

SVL22

[1000 WATT MAX.]

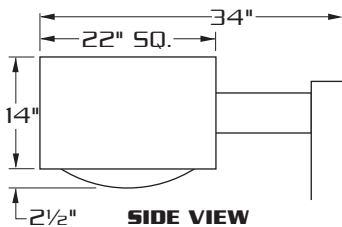

SIDE VIEW

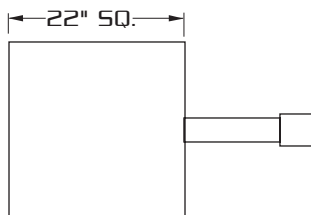

TOP VIEW

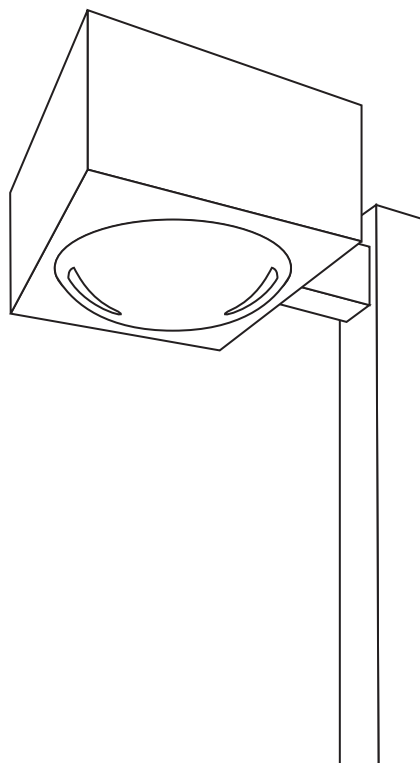

E.P.A.- 3.20



WM



1



2-180



2-90



3-90



3-120



4-90

SPECIFICATIONS

HOUSING: ONE PIECE DIE FORMED ALUMINUM CONSTRUCTION WITH SEPARATE BALLAST COMPARTMENT.

LENS ASS'Y: ONE PIECE HINGED HEAVY GAUGE DIE FORMED ALUMINUM DOOR FRAME SURROUNDS 3/16" CLEAR CONVEX GLASS LENS. GLASS IS SEALED TO DOOR WITH HIGH TEMPERATURE SILICONE SEAL. TWO CAPTIVE THUMB SCREWS DISENGAGE LENS ASSEMBLY FROM HOUSING WITHOUT THE USE OF TOOLS.

OPTICS: COMPUTER DESIGNED ONE PIECE SEGMENTED SPECULAR REFLECTOR COMBINES WITH CLEAR CONVEX LENS TO PRODUCE A HIGHLY EFFICIENT WIDE SYMMETRIC LIGHT DISTRIBUTION WITH OUTSTANDING UNIFORMITY.

GASKETING: CLOSED CELL EPDM GASKETING COMPRESSED BETWEEN DOOR AND HOUSING SEALS OPTICAL CHAMBER.

LAMP HOLDER: MOGUL BASE PORCELAIN.

LAMP: (BY OTHERS)

BALLAST: H.P.F./C.W.A. AUTOTRANSFORMER. -20° STARTING TEMPERATURE.

ARM: 3"X5"X12" LONG HEAVY WALL EXTRUDED ALUMINUM. ARM IS SECURED TO HOUSING AND TO POLE WITH STAINLESS STEEL RODS.

FINISH: POLYESTER POWDER COAT-STATE OF THE ART 20 PSI PRESSURE POWER WASH AT 140° TEMPERATURE INCORPORATES FOUR STEP IRON PHOSPHATE PROCESS TO CLEANSE AND PRETREAT THE METAL SURFACE FOR MAXIMUM PAINT ADHESION. ELECTROSTATICALLY APPLIED TEXTURED POLYESTER POWDER TOP COAT IS BAKED AT 400° TEMPERATURE FOR MAXIMUM HARDNESS AND EXTERIOR DURABILITY.



660 WEST AVENUE O, PALMDALE, CA. 93551
(661) 233-2000
FAX NO. (661) 233-2001
www.usaltg.com

A5-1

TYPICAL SQUARE POLE TEMPLATE

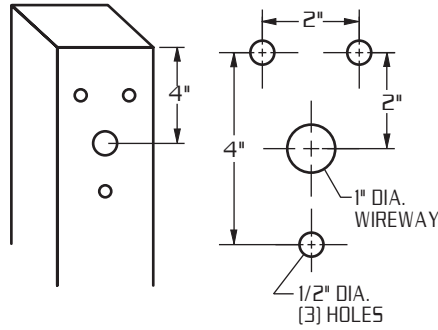

TYPICAL ROUND POLE TEMPLATE

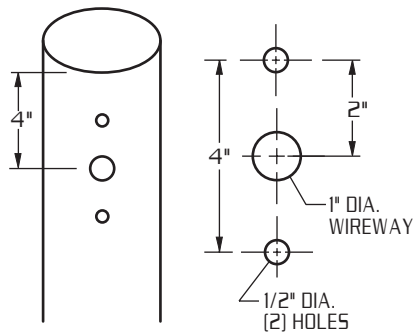

WALL MOUNT

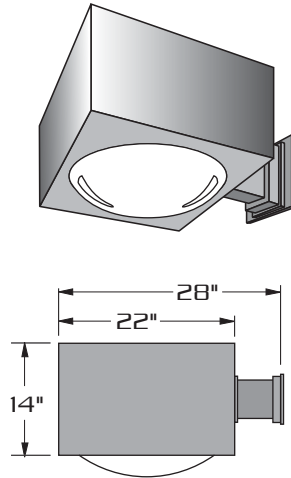

EXTRUDED ALUMINUM ARM AND CAST ALUMINUM WALL BRACKET ASSEMBLY PROVIDED WITH BUILT IN GASKETED WIRE ACCESS FOR FIXTURE/SUPPLY WIRE CONNECTION.

WALL PLATE

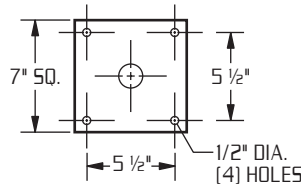

**LAMP SIZE:
250 - 1000 WATT**

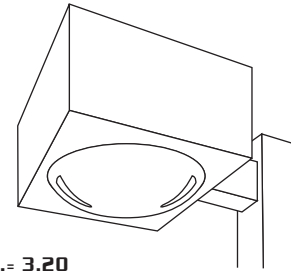

E.P.A. = 3.20

- WIDE THROW BEAM PATTERN.**
- VERTICAL LAMP.**
- COMPUTER DESIGNED SEGMENTED OPTICS.**
- THREE OPTICAL CONFIGURATIONS.**
- FLAT GLASS OPTION FOR FULL CUTOFF OPTICS.**

ORDERING INFORMATION

MODEL NO. :	OPTICS	WATTAGE TYPE VOLTAGE	MOUNTING	FINISH	OPTIONS
SVL22					

MODEL NO. :	OPTICS	LAMP	MOUNTING	FINISH	OPTIONS
S V L 2 2	<input type="checkbox"/> ASYMMETRIC ASY...	<input type="checkbox"/> 1000 MH (BT37) <input type="checkbox"/> 120 <input type="checkbox"/> 1000 PSMH (BT37) <input type="checkbox"/> 208 <input type="checkbox"/> 750 PSMH (BT37) <input type="checkbox"/> 240 <input type="checkbox"/> 450 PSMH (ED37) <input type="checkbox"/> 277 <input type="checkbox"/> 400 MH (ED37) <input type="checkbox"/> 480 <input type="checkbox"/> 400 PSMH (ED37) <input type="checkbox"/> MT	<input type="checkbox"/> 1 <input type="checkbox"/>	<input type="checkbox"/> DARK BRONZE DBM <input type="checkbox"/> MEDIUM BRONZE MBM <input type="checkbox"/> BLACK BKM <input type="checkbox"/> WHITE WTM <input type="checkbox"/> SILVER SLM	<input type="checkbox"/> FLAT TEMPERED GLASS..... FG <input type="checkbox"/> CLEAR POLYCARBONATE DIFFUSER..... LEX <input type="checkbox"/> HOUSE SIDE SHIELD..... HS <input type="checkbox"/> PHOTO CELL + VOLTAGE (EXAMPLE: PC120V)..... PC+V <input type="checkbox"/> TWIST LOCK PHOTO CELL+VOLTAGE (EXAMPLE TPC120V)..... TPC+V <input type="checkbox"/> TWIST LOCK RECEPTACLE ONLY..... TPR
	<input type="checkbox"/> TYPE IV (FORWARD THROW) IV..... <input type="checkbox"/> TYPE V V-SQ...	<input type="checkbox"/> 750 HPS (BT37) <input type="checkbox"/> 400 HPS (ED18)	<input type="checkbox"/> ST 23..... <input type="checkbox"/> (TO FIT OVER 2 3/8" O.D. ARM) <input type="checkbox"/> ADJUSTABLE KNUCKLE <input type="checkbox"/> NKLE23..... <input type="checkbox"/> (TO FIT OVER 2 3/8" O.D.) <input type="checkbox"/> NKLE27..... <input type="checkbox"/> (TO FIT OVER 2 7/8" O.D.)	<input type="checkbox"/> ANODIZED AZ ANODIZED HOUSING MUST HAVE PAINT FINISH COAT EXAMPLE: AZDBM SEE PAGE 3 FOR ADDITIONAL COLORS	<input type="checkbox"/> SINGLE FUSE (120V. , 277V)..... SF <input type="checkbox"/> DOUBLE FUSE (208V. , 240V)..... DF



660 WEST AVENUE O, PALMDALE, CA. 93551
 (661) 233-2000
 FAX NO. (661) 233-2001
 www.usaltg.com