

# RVL25

[400 WATT MAX.]

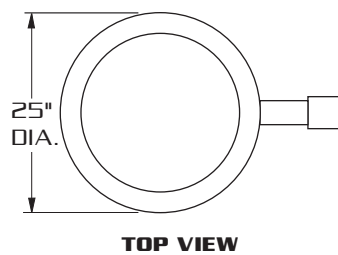

E.P.A.= 1.85

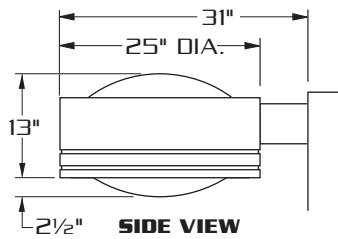

WM



1



2-180



2-90



3-90



3-120



4-90

## SPECIFICATIONS

**HOUSING:** HEAVY WALL SPUN ALUMINUM CONSTRUCTION WITH INTEGRAL DOMED TOP. TWIN FLUTES HAVE BEEN INTEGRATED WITH HOUSING TO ADD AESTHETIC VALUE AND TO PROVIDE FOR MULTI COLORED BANDS TO SIGNATURIZE INSTALLATION.

**LENS ASS'Y:** ONE PIECE HINGED HEAVY GAUGE DIE FORMED ALUMINUM DOOR FRAME SURROUNDS 3/16" CLEAR CONVEX GLASS LENS. GLASS IS SEALED TO DOOR WITH HIGH TEMPERATURE SILICONE SEAL. CAPTIVE THUMB SCREW DISENGAGES LENS ASSEMBLY AND ACTIVATES ACCUHINGE™ HINGE TO ALLOW LENS ASSEMBLY TO HINGE AWAY FROM HOUSING FOR LUMINAIRE ACCESS WITHOUT THE USE OF TOOLS.

**OPTICS:** COMPUTER DESIGNED ONE PIECE SEGMENTED SPECULAR REFLECTOR COMBINES WITH CLEAR CONVEX LENS TO PRODUCE A HIGHLY EFFICIENT WIDE SYMMETRIC LIGHT DISTRIBUTION WITH OUTSTANDING UNIFORMITY.

**GASKETING:** CLOSED CELL EPDM GASKETING COMPRESSED BETWEEN DOOR AND HOUSING WORKS IN COMBINATION WITH ACCUHINGE™ HINGE TO PRESSURE SEAL OPTICAL CHAMBER.

**LAMP HOLDER:** MOGUL BASE PORCELAIN.

**LAMP:** (BY OTHERS)

**BALLAST:** H.P.F./C.W.A. AUTOTRANSFORMER. -20° STARTING TEMPERATURE.

**ARM:** 3"X5"X6" LONG HEAVY WALL EXTRUDED ALUMINUM. ARM IS SECURED TO HOUSING AND TO POLE WITH STAINLESS STEEL RODS.

**FINISH:** POLYESTER POWDER COAT-STATE OF THE ART 20 PSI PRESSURE POWER WASH AT 140° TEMPERATURE INCORPORATES FOUR STEP IRON PHOSPHATE PROCESS TO CLEANSE AND PRETREAT THE METAL SURFACE FOR MAXIMUM PAINT ADHESION. ELECTROSTATICALLY APPLIED TEXTURED POLYESTER POWDER TOP COAT IS BAKED AT 400° TEMPERATURE FOR MAXIMUM HARDNESS AND EXTERIOR DURABILITY.



660 WEST AVENUE O, PALMDALE, CA. 93551  
(661) 233-2000  
FAX NO. (661) 233-2001  
www.usaltg.com

A8-1  
REV. 10 / 03

**TYPICAL SQUARE POLE TEMPLATE**

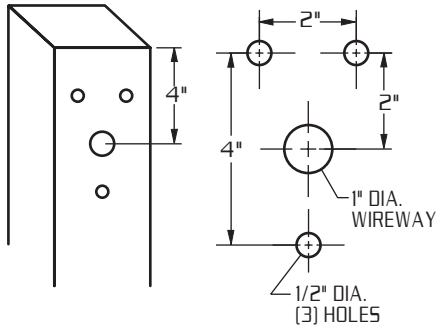

**TYPICAL ROUND POLE TEMPLATE**

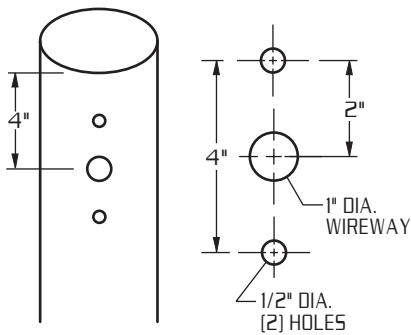

**WALL MOUNT**

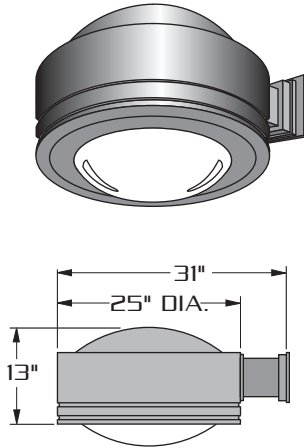

EXTRUDED ALUMINUM ARM AND CAST ALUMINUM WALL BRACKET ASSEMBLY PROVIDED WITH BUILT IN GASKETED WIRE ACCESS FOR FIXTURE/SUPPLY WIRE CONNECTION.

**WALL PLATE**

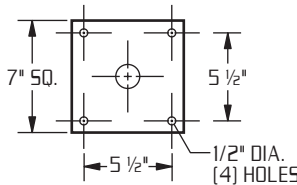

**LAMP SIZE:  
250 - 400 WATT**

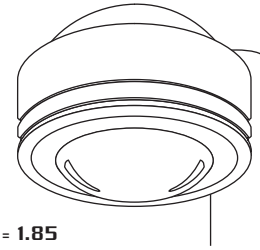

E.P.A. = 1.85

- WIDE THROW BEAM PATTERN.**
- VERTICAL LAMP.**
- COMPUTER DESIGNED SEGMENTED OPTICS.**
- THREE OPTICAL CONFIGURATIONS.**
- FLAT GLASS OPTION FOR FULL CUTOFF OPTICS.**

**ORDERING INFORMATION**

MODEL NO. : <b>RVL25</b>	OPTICS	WATTAGE TYPE VOLTAGE	MOUNTING	FINISH	OPTIONS
<b>R V L 2 5</b>	<input type="checkbox"/> ASYMMETRIC <b>ASY...</b>	<input type="checkbox"/> <b>450 PSMH</b> (ED37) <input type="checkbox"/> <b>120</b> <input type="checkbox"/> <b>400 MH</b> (ED37,ED28) <input type="checkbox"/> <b>208</b> <input type="checkbox"/> <b>400 PSMH</b> (ED37,ED28) <input type="checkbox"/> <b>240</b> <input type="checkbox"/> <b>350 PSMH</b> (ED37,ED28) <input type="checkbox"/> <b>480</b> <input type="checkbox"/> <b>250 MH</b> (ED28) <input type="checkbox"/> <b>MT</b> <input type="checkbox"/> <b>250 PSMH</b> (ED28)  <input type="checkbox"/> <b>400 HPS</b> (ED18) <input type="checkbox"/> <b>250 HPS</b> (ED18)  FOR MH OR PSMH WITH <b>FG</b> OPTION USE ED28	<input type="checkbox"/> <b>1</b> ..... ●  <b>STREET LIGHTING ARM MOUNT</b> <input type="checkbox"/> <b>ST 23</b> ..... ● (TO FIT OVER 2 3/8" O.D. ARM)  <b>ADJUSTABLE KNUCKLE</b> <input type="checkbox"/> <b>NKLE23</b> ..... ● (TO FIT OVER 2 3/8" O.D.)  <input type="checkbox"/> <b>NKLE27</b> ..... ● (TO FIT OVER 2 7/8" O.D.)  <b>WALL MOUNT</b> <input type="checkbox"/> <b>WM</b> ..... ●  SEE ACCESSORIES SECTION FOR ST23 AND NKLE DETAILS	<input type="checkbox"/> DARK BRONZE <b>DBM</b> <input type="checkbox"/> MEDIUM BRONZE <b>MBM</b> <input type="checkbox"/> BLACK <b>BKM</b> <input type="checkbox"/> WHITE <b>WTM</b> <input type="checkbox"/> SILVER <b>SLM</b>  <b>OPTION:</b> <input type="checkbox"/> ANODIZED <b>AZ</b> ANODIZED HOUSING MUST HAVE PAINT FINISH COAT EXAMPLE: <b>AZDBM</b>  SEE PAGE 3 FOR ADDITIONAL COLORS	<input type="checkbox"/> FLAT TEMPERED GLASS..... <b>FG</b> <input type="checkbox"/> CLEAR POLYCARBONATE DIFFUSER ..... <b>LEX</b> <input type="checkbox"/> HOUSE SIDE SHIELD ..... <b>HS</b>  <input type="checkbox"/> PHOTO CELL + VOLTAGE (EXAMPLE: PC120V) ..... <b>PC+V</b> <input type="checkbox"/> TWIST LOCK PHOTO CELL+VOLTAGE (EXAMPLE TPC120V) ..... <b>TPC+V</b>  <input type="checkbox"/> TWIST LOCK RECEPTACLE ONLY..... <b>TPR</b> <input type="checkbox"/> SINGLE FUSE (120V. , 277V) ..... <b>SF</b> <input type="checkbox"/> DOUBLE FUSE (208V. , 240V) ..... <b>DF</b>



660 WEST AVENUE O, PALMDALE, CA. 93551  
 (661) 233-2000  
 FAX NO. (661) 233-2001  
[www.usaltg.com](http://www.usaltg.com)