

RSB25

[400 WATT MAX.]

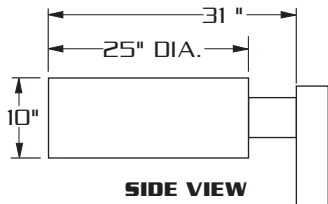

SIDE VIEW

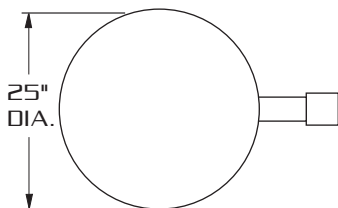

TOP VIEW



E.P.A.= 1.55



WM



1



2-180



2-90



3-90



3-120



4-90

SPECIFICATIONS

HOUSING: HEAVY WALL SPUN ALUMINUM CONSTRUCTION. ENTIRE HOUSING SURFACE SHALL BE FREE OF WELDS OR SEAMS.

LENS ASS'Y: ONE PIECE HINGED HEAVY GAUGE DIE FORMED ALUMINUM DOOR FRAME SURROUNDS 3/16" CLEAR TEMPERED GLASS LENS. GLASS IS SEALED TO DOOR WITH HIGH TEMPERATURE SILICONE SEAL. CAPTIVE THUMB SCREW DISENGAGES LENS ASSEMBLY AND ACTIVATES ACCUHINGE™ HINGE TO ALLOW LENS ASSEMBLY TO HINGE AWAY FROM HOUSING FOR LUMINAIRE ACCESS WITHOUT THE USE OF TOOLS.

OPTICS: COMPUTER DESIGNED ONE PIECE SEMI SPECULAR HYDROFORMED REFLECTOR. COMBINES WITH CLEAR TEMPERED GLASS LENS TO PRODUCE A HIGHLY EFFICIENT, SHARP CUTOFF.

GASKETING: CLOSED CELL EPDM GASKETING COMPRESSED BETWEEN DOOR AND HOUSING WORKS IN COMBINATION WITH ACCUHINGE™ HINGE TO PRESSURE SEAL OPTICAL CHAMBER.

LAMP HOLDER: MOGUL BASE PORCELAIN.

LAMP: (BY OTHERS)

BALLAST: H.P.F./C.W.A. AUTOTRANSFORMER. -20° STARTING TEMPERATURE.

ARM: 3"X5"X6" LONG HEAVY WALL EXTRUDED ALUMINUM. ARM IS SECURED TO HOUSING AND TO POLE WITH STAINLESS STEEL RODS.

FINISH: POLYESTER POWDER COAT-STATE OF THE ART 20 PSI PRESSURE POWER WASH AT 140° TEMPERATURE INCORPORATES FOUR STEP IRON PHOSPHATE PROCESS TO CLEANSE AND PRETREAT THE METAL SURFACE FOR MAXIMUM PAINT ADHESION. ELECTROSTATICALLY APPLIED TEXTURED POLYESTER POWDER TOP COAT IS BAKED AT 400° TEMPERATURE FOR MAXIMUM HARDNESS AND EXTERIOR DURABILITY.



660 WEST AVENUE O, PALMDALE, CA. 93551

(661) 233-2000

FAX NO. (661) 233-2001

www.usaltg.com

A7-3
REV. 10 / 03

TYPICAL SQUARE POLE TEMPLATE

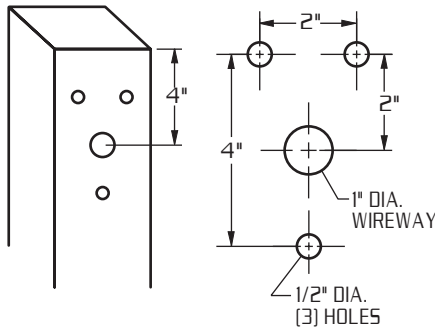

WALL MOUNT

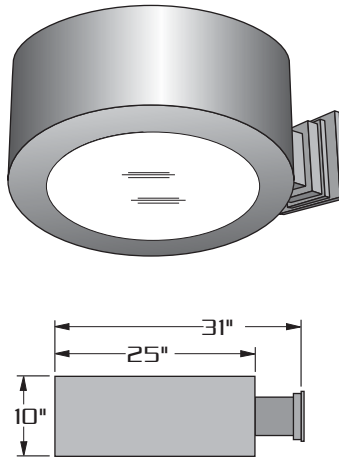

**LAMP SIZE:
250 - 400 WATT**

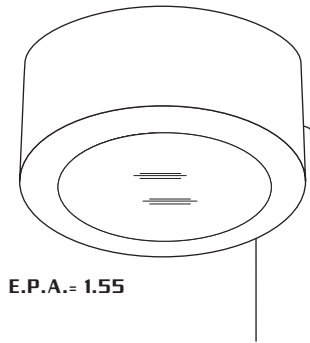

E.P.A. = 1.55

TYPICAL ROUND POLE TEMPLATE

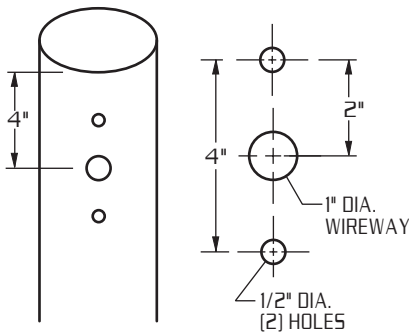

EXTRUDED ALUMINUM ARM AND CAST ALUMINUM WALL BRACKET ASSEMBLY PROVIDED WITH BUILT IN GASKETED WIRE ACCESS FOR FIXTURE/SUPPLY WIRE CONNECTION.

WALL PLATE

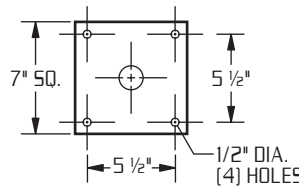





HEAVY GAUGE SPUN ALUMINUM HOUSING.

FIVE LIGHT DISTRIBUTIONS AVAILABLE.

OPTICAL SYSTEMS ENCLOSED IN IMPACT RESISTANT TEMPERED GLASS LENS.

TOOLESS ENTRY TO LAMP COMPARTMENT.

ORDERING INFORMATION

MODEL NO. : RSB25	OPTICS	WATTAGE TYPE VOLTAGE	MOUNTING	FINISH	OPTIONS
MODEL NO. : RSB25	OPTICS	LAMP	MOUNTING	FINISH	OPTIONS
R S B 2 5	<input type="checkbox"/> TYPE II II..... (hydroform)  <input type="checkbox"/> TYPE III III..... (hydroform)  <input type="checkbox"/> TYPE IV (FORWARD THROW) IV..... (segmented)  <input type="checkbox"/> TYPE V V-SQ... (segmented) 	<input type="checkbox"/> 400 <input type="checkbox"/> HPS <input type="checkbox"/> 120 <input type="checkbox"/> 250 <input type="checkbox"/> MH <input type="checkbox"/> 208 <input type="checkbox"/> MV <input type="checkbox"/> 240 <input type="checkbox"/> 277 <input type="checkbox"/> 480 <input type="checkbox"/> MT	ARM MOUNT <input type="checkbox"/> 1 ● STREET LIGHTING ARM MOUNT <input type="checkbox"/> ST 23 ● (TO FIT OVER 2 3/8" O.D. ARM) ADJUSTABLE KNUCKLE <input type="checkbox"/> NKLE23 ● (TO FIT OVER 2 3/8" O.D.) <input type="checkbox"/> NKLE27 ● (TO FIT OVER 2 7/8" O.D.) WALL MOUNT <input type="checkbox"/> WM ● SEE ACCESSORIES SECTION FOR ST23 AND NKLE DETAILS	<input type="checkbox"/> DARK BRONZE DBM <input type="checkbox"/> MEDIUM BRONZE MBM <input type="checkbox"/> BLACK BKM <input type="checkbox"/> WHITE WTM <input type="checkbox"/> SILVER SLM OPTION: <input type="checkbox"/> ANODIZED AZ ANODIZED HOUSING MUST HAVE PAINT FINISH COAT EXAMPLE: AZDBM SEE PAGE 3 FOR ADDITIONAL COLORS	<input type="checkbox"/> CLEAR POLYCARBONATE DIFFUSER LEX <input type="checkbox"/> HOUSE SIDE SHIELD HS <input type="checkbox"/> PHOTO CELL + VOLTAGE (EXAMPLE: PC120V) PC+V <input type="checkbox"/> TWIST LOCK PHOTO CELL+VOLTAGE (EXAMPLE TPC120V) TPC+V <input type="checkbox"/> TWIST LOCK RECEPTACLE ONLY TPR <input type="checkbox"/> SINGLE FUSE (120V., 277V) SF <input type="checkbox"/> DOUBLE FUSE (208V., 240V) DF
		METAL HALIDE UNITS ONLY USE ED28 LAMP FOR 400 W.			



660 WEST AVENUE O, PALMDALE, CA. 93551
(661) 233-2000
FAX NO. (661) 233-2001
www.usaltg.com