

GALAXY 7

[400 WATT MAX.]

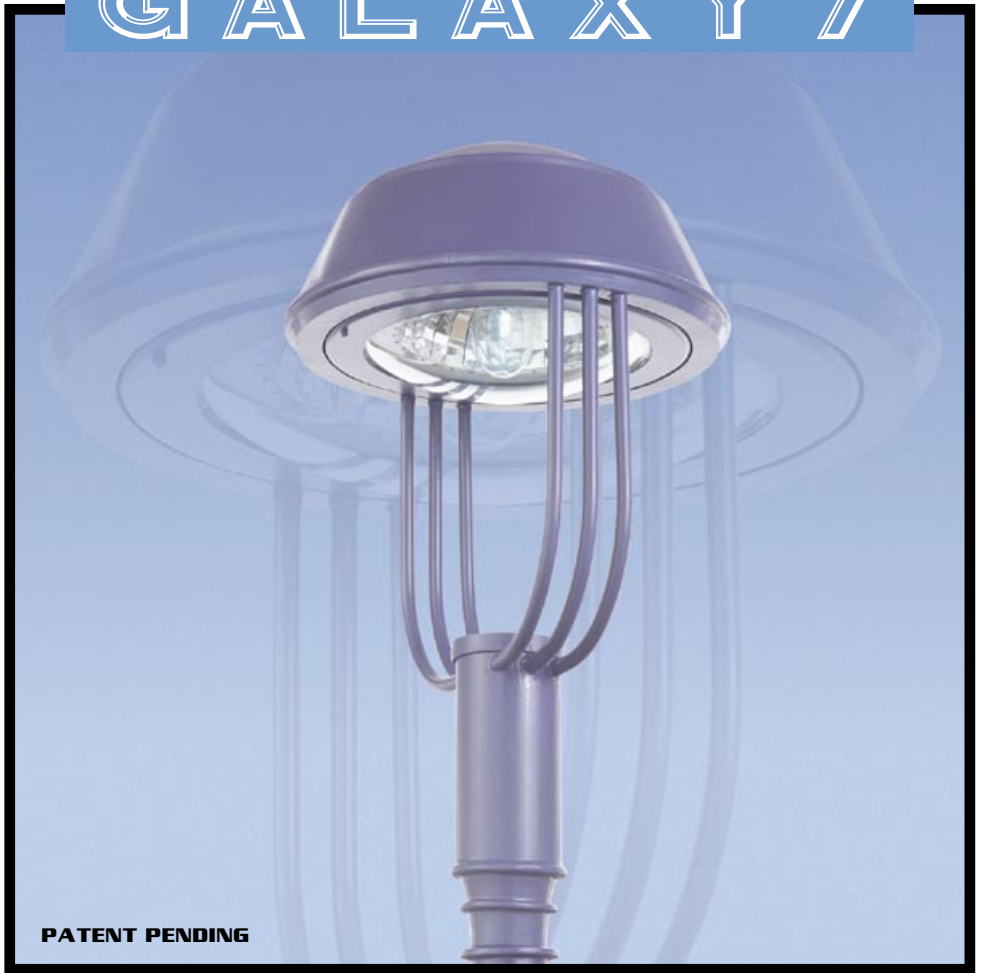
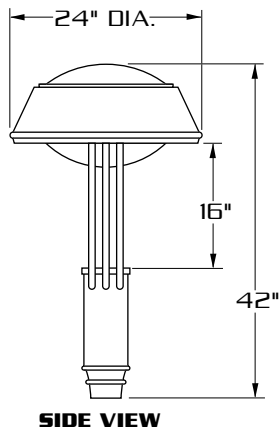
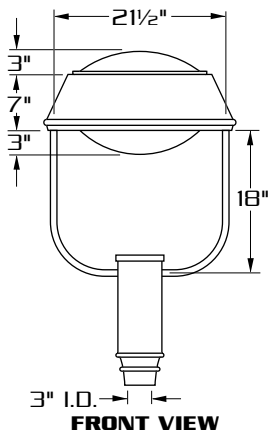

SPECIFICATIONS

HOUSING: DURABLE, CORROSION RESISTANT, PRECISE CAST ALUMINUM CONSTRUCTION.

LENS ASS'Y: ONE PIECE, DIE FORMED ALUMINUM DOOR FRAME SURROUNDS LENS. LENS IS SEALED TO DOOR FRAME WITH HIGH TEMPERATURE SILICONE SEAL. CAPTIVE THUMB SCREW IS LOOSENED TO DISENGAGE LENS ASSEMBLY FROM HOUSING. THIS ACTIVATES ACCUHINGE™ TO ALLOW LENS ASSEMBLY TO HINGE AWAY FROM HOUSING FOR LUMINAIRE ACCESS WITHOUT USE OF TOOLS.

OPTICS: COMPUTER DESIGNED ONE PIECE SPECULAR SEGMENTED REFLECTOR COMBINES WITH CLEAR TEMPERED CONVEX LENS TO PRODUCE A WIDE SYMMETRIC EFFICIENT LIGHT DISTRIBUTION WITH OUTSTANDING UNIFORMITY. (OTHER OPTICS AVAILABLE. SEE ORDERING INFORMATION)

GASKETING: CLOSED CELL EPDM GASKETING COMPRESSED BETWEEN DOOR FRAME AND HOUSING WORKS IN COMBINATION WITH ACCUHINGE™ TO PRESSURE SEAL OPTICAL CHAMBER AND PREVENT ENTRY OF CONTAMINANTS INTO OPTICAL CHAMBER.

LAMP HOLDER: MOGUL BASE PORCELAIN.

LAMP: (BY OTHERS)

BALLAST: H.P.F./C.W.A. AUTOTRANSFORMER. -20° STARTING TEMPERATURE.

ARM ASS'Y: SIX (6) EXTRUDED ALUMINUM (.84 O.D.) ARMS ARE WELDED TO AN EXTRUDED ALUMINUM ARM FITTER. ARMS ARE INTERNALLY WELDED TO HOUSING TO COSMETICALLY CONCEAL WELDS. GASKETED ARM FITTER HOUSES BALLAST.

FINISH: POLYESTER POWDER COAT-STATE OF THE ART 20 PSI PRESSURE POWER WASH AT 140° TEMPERATURE INCORPORATES FOUR STEP IRON PHOSPHATE PROCESS TO CLEANSE AND PRETREAT THE METAL SURFACE FOR MAXIMUM PAINT ADHESION. ELECTROSTATICALLY APPLIED TEXTURED POLYESTER POWDER TOPCOAT IS BAKED AT 400° TEMPERATURE FOR MAXIMUM HARDNESS AND EXTERIOR DURABILITY.



GLX-711

E.P.A. = 1.47

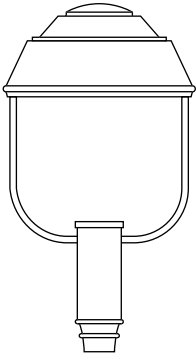

- SOLID PYRAMID TOP
- TEMPERED GLASS LENS
- HORIZONTAL LAMP
- 400 W. MAX LAMP

GLX-712

E.P.A. = 1.60

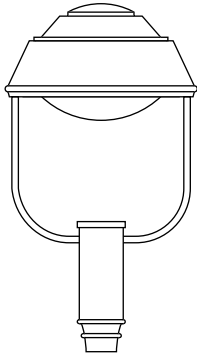

- SOLID PYRAMID TOP
- CONVEX GLASS LENS
- HORIZONTAL OR VERTICAL LAMP
- 400 W. MAX. LAMP

GLX-713

E.P.A. = 1.60

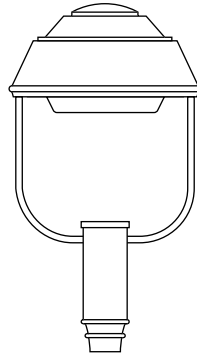

- SOLID PYRAMID TOP
- DROP GLASS LENS
- HORIZONTAL LAMP
- 400 W. MAX. LAMP

GLX-714

E.P.A. = 1.97

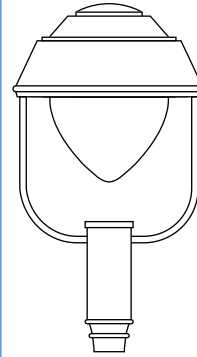

- SOLID PYRAMID TOP
- TEAR DROP ACRYLIC
- HORIZONTAL OR VERTICAL LAMP
- 250 W. MAX. LAMP

GLX-721

E.P.A. = 1.38

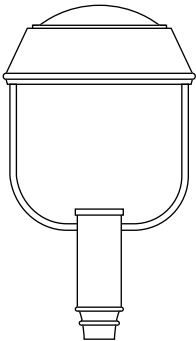

- SOLID DOME TOP
- TEMPERED GLASS LENS
- HORIZONTAL LAMP
- 400 W. MAX LAMP

GLX-722

E.P.A. = 1.51

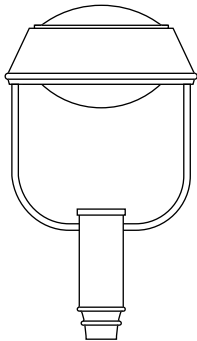

- SOLID DOME TOP
- CONVEX GLASS LENS
- HORIZONTAL OR VERTICAL LAMP
- 400 W. MAX LAMP

GLX-723

E.P.A. = 1.51

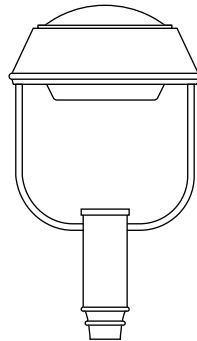

- SOLID DOME TOP
- DROP GLASS LENS
- HORIZONTAL LAMP
- 400 W. MAX LAMP

GLX-724

E.P.A. = 1.88

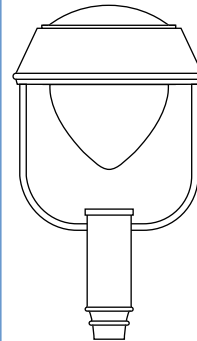

- SOLID DOME TOP
- TEAR DROP ACRYLIC
- HORIZONTAL OR VERTICAL LAMP
- 250 W. MAX. LAMP

GLX-731

E.P.A. = 1.41

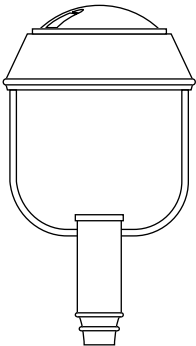

- UP-LIGHT
- TEMPERED GLASS LENS
- HORIZONTAL LAMP
- 400 W. MAX. LAMP

GLX-732

E.P.A. = 1.54

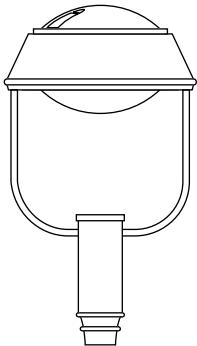

- UP-LIGHT
- CONVEX GLASS LENS
- HORIZONTAL LAMP
- 400 W. MAX. LAMP

GLX-733

E.P.A. = 1.54

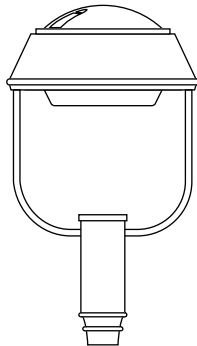

- UP-LIGHT
- DROP GLASS LENS
- HORIZONTAL LAMP
- 400 W. MAX. LAMP

GLX-734

E.P.A. = 1.91

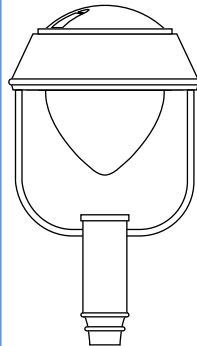

- UP-LIGHT
- TEAR DROP ACRYLIC
- HORIZONTAL LAMP
- 250 W. MAX. LAMP

GLX-741

E.P.A. = 1.43

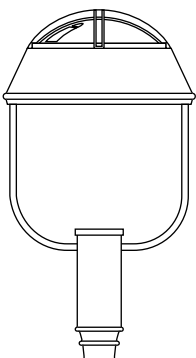

- UP-LIGHT WITH CAST GUARD
- TEMPERED GLASS LENS
- HORIZONTAL LAMP
- 400 W. MAX. LAMP

GLX-742

E.P.A. = 1.56

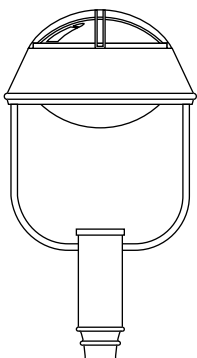

- UP-LIGHT WITH CAST GUARD
- CONVEX GLASS LENS
- HORIZONTAL LAMP
- 400 W. MAX. LAMP

GLX-743

E.P.A. = 1.56

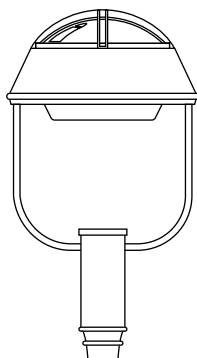

- UP-LIGHT WITH CAST GUARD
- DROP GLASS LENS
- HORIZONTAL LAMP
- 400 W. MAX. LAMP

GLX-744

E.P.A. = 1.93

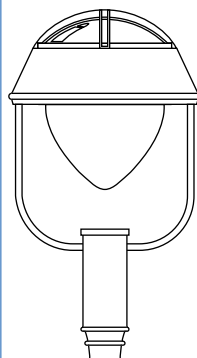

- UP-LIGHT WITH CAST GUARD
- TEAR DROP ACRYLIC
- HORIZONTAL LAMP
- 250 W. MAX. LAMP

WALL MOUNT

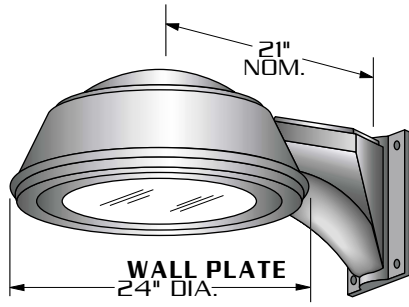

CORROSION RESISTANT CAST ALUMINUM ARM IS SUPPLIED WITH REMOVABLE CAST ALUMINUM TOP CAP FOR EASY ACCESS TO ELECTRICAL COMPONENTS.

WALL PLATE

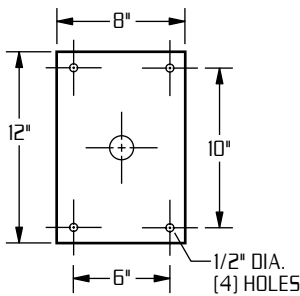

LAMP SIZE:
70 - 400 WATT

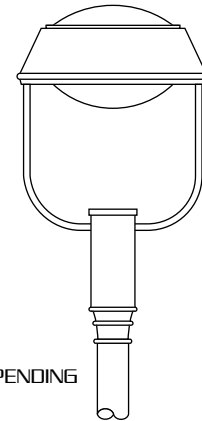

PATENT PENDING

DURABLE CAST ALUMINUM CONSTRUCTION.

HORIZONTAL AND VERTICAL LAMP OPTIONS.

FIVE LIGHT DISTRIBUTIONS.

DECORATIVE UPLIGHT COMPONENT. (730 AND 740 SERIES)

ORDERING INFORMATION

MODEL NO. : GLX-	OPTICS	WATTAGE TYPE VOLTAGE	MOUNTING	FINISH	OPTIONS
GLX	HORIZONTAL LAMP REFLECTORS	WATTAGE TYPE VOLTAGE	<input type="checkbox"/> PT..... ●	<input type="checkbox"/> DARK BRONZE DBM	<input type="checkbox"/> HOUSE SIDE SHIELD
	<input type="checkbox"/> TYPE II HR-II..... (hydroform, horizontal lamp)	<input type="checkbox"/> 400 <input type="checkbox"/> HPS <input type="checkbox"/> 120	WALL MOUNT <input type="checkbox"/> WM..... ●	<input type="checkbox"/> MEDIUM BRONZE MBM	90° HS 90°
	<input type="checkbox"/> TYPE III HR-III..... (segmented, horizontal lamp)	<input type="checkbox"/> 250 <input type="checkbox"/> MH <input type="checkbox"/> 208		<input type="checkbox"/> BLACK BKM	135° HS 135°
	<input type="checkbox"/> TYPE IV (FORWARD THROW) HR-IV..... (segmented, horizontal lamp)	<input type="checkbox"/> 200 <input type="checkbox"/> MV <input type="checkbox"/> 240		<input type="checkbox"/> WHITE WTM	180° HS 180°
	<input type="checkbox"/> TYPE V HR-V-SQ (segmented, horizontal lamp)	<input type="checkbox"/> 175 <input type="checkbox"/> 277		<input type="checkbox"/> SILVER SLM	<input type="checkbox"/> PHOTO CELL + VOLTAGE (EXAMPLE: PC120V) PC+V
	<input type="checkbox"/> TYPE IV (FORWARD THROW) HR-IV..... (segmented, horizontal lamp)	<input type="checkbox"/> 150 <input type="checkbox"/> 480			<input type="checkbox"/> SINGLE FUSE (120V., 277V) SF
	<input type="checkbox"/> TYPE V HR-V-SQ (segmented, horizontal lamp)	<input type="checkbox"/> 100 <input type="checkbox"/> MT			<input type="checkbox"/> DOUBLE FUSE (208V., 240V) DF
	<input type="checkbox"/> TYPE V HR-V-SQ (segmented, horizontal lamp)	<input type="checkbox"/> 75			
	<input type="checkbox"/> TYPE V HR-V-SQ (segmented, horizontal lamp)	<input type="checkbox"/> 70			
	VERTICAL LAMP REFLECTORS				
<input type="checkbox"/> ASYMMETRIC ASY..... (segmented, vertical lamp)					
<input type="checkbox"/> TYPE V VR-V-SQ (segmented, vertical lamp)					
	METAL HALIDE UNITS ONLY USE ED28 LAMP FOR 400 W. USE MEDIUM BASE LAMP FOR 100 W.			SEE PAGE 3 FOR ADDITIONAL COLORS	



A uniquely conceived "first" in outdoor area lighting featuring an unprecedented variety of designs and a wide range of computer designed optical systems, entirely sealed for maximum efficiency, and manufactured for maintenance ease through tool-less luminaire access. All designs are enclosed in a weather-resistant, precisely designed cast aluminum housing.

An unequaled ninety six (96) style collection Highlighting:
 ✦ Street and roadway cutoff lighting featuring computer engineered controlled beam spreads;
 ✦ Vertical lamp luminaires for large area lighting featuring highly efficient wide spacing to mounting height ratios;
 ✦ Decorative site lighting with companion wall mount luminaires.

The epitome of versatility
 ✦ Arm mount and post top cutoff luminaires;
 ✦ Dual function cutoffs (up/down light);
 ✦ Arm mount and post top wide angle vertical lamp units;
 ✦ Dual function wide angle units (up/down light);
 ✦ Arm mount and post top decorative units;
 ✦ Dual function decorative units (up/down light);
 ✦ Five light distributions;
 ✦ Four lens styles.

Blending of form and function is evidenced in the **design** of the **GALAXY** collection, combined with numerous **high performance** reflector and refractor generated optics to provide exceptional lighting performance. **GALAXY** design and engineering utilizes high intensity discharge lamp sources - from 70 to 400 watts - in wall mount, arm mount, or post top styles - to provide you with a family of luminaires to signaturize your project with architecture by day and security by night.

GALAXY 7

	SOLID PYRAMID TOP 10				SOLID DOME TOP 20				UP-LIGHT 30				UP-LIGHT WITH CAST GUARD 40			
	TEMPERED GLASS LENS	CONVEX GLASS LENS	DROP GLASS LENS	TEAR DROP ACRYLIC	TEMPERED GLASS LENS	CONVEX GLASS LENS	DROP GLASS LENS	TEAR DROP ACRYLIC	TEMPERED GLASS LENS	CONVEX GLASS LENS	DROP GLASS LENS	TEAR DROP ACRYLIC	TEMPERED GLASS LENS	CONVEX GLASS LENS	DROP GLASS LENS	TEAR DROP ACRYLIC
	1	2	3	4	1	2	3	4	1	2	3	4	1	2	3	4
100 CONTEMPO ARM	GLX-111	GLX-112	GLX-113	GLX-114	GLX-121	GLX-122	GLX-123	GLX-124								
200 ARCHED ARM	GLX-211	GLX-212	GLX-213	GLX-214	GLX-221	GLX-222	GLX-223	GLX-224								
300 DECORATIVE ARM	GLX-311	GLX-312	GLX-313	GLX-314	GLX-321	GLX-322	GLX-323	GLX-324	GLX-331	GLX-332	GLX-333	GLX-334	GLX-341	GLX-342	GLX-343	GLX-344
400 STREET LTG. ARM	GLX-411	GLX-412	GLX-413	GLX-414	GLX-421	GLX-422	GLX-423	GLX-424	GLX-431	GLX-432	GLX-433	GLX-434	GLX-441	GLX-442	GLX-443	GLX-444
500 YOKE ARM	GLX-511	GLX-512	GLX-513	GLX-514	GLX-521	GLX-522	GLX-523	GLX-524	GLX-531	GLX-532	GLX-533	GLX-534	GLX-541	GLX-542	GLX-543	GLX-544
600 OFFSET ARM	GLX-611	GLX-612	GLX-613	GLX-614	GLX-621	GLX-622	GLX-623	GLX-624	GLX-631	GLX-632	GLX-633	GLX-634	GLX-641	GLX-642	GLX-643	GLX-644
700 POSTTOP ARM	GLX-711	GLX-712	GLX-713	GLX-714	GLX-721	GLX-722	GLX-723	GLX-724	GLX-731	GLX-732	GLX-733	GLX-734	GLX-741	GLX-742	GLX-743	GLX-744



660 WEST AVENUE O, PALMDALE, CA. 93551
 (661) 233-2000
 FAX NO. (661) 233-2001
www.usaltg.com