

DSAPM

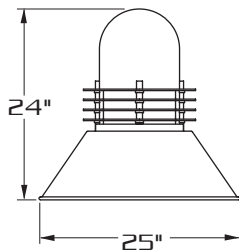

DSAPM25
[250 W. MAX.]

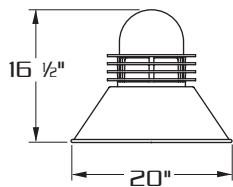

DSAPM1
[175 W. MAX.]

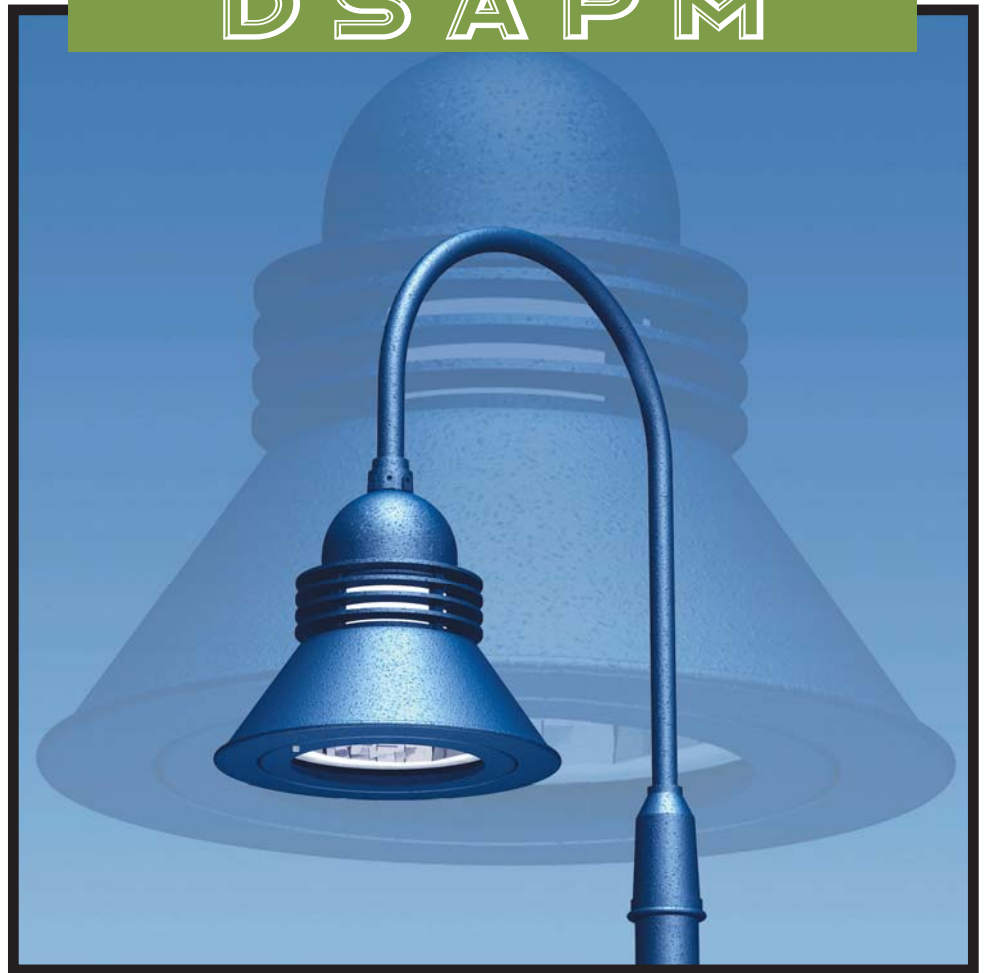

E.P.A. **DSAPM25**- 1.52
DSAPM1- 0.88



WM



1



2-180



2-90



3-90



3-120



4-90

SPECIFICATIONS

HOUSING: DURABLE ONE PIECE HEAVY WALL CAST ALUMINUM CONSTRUCTION WITH REMOVABLE BALLAST TRAY FOR EASY BALLAST ACCESS. HOUSING PROVIDED WITH UPLIGHT COMPONENT AND DECORATIVE CAST ALUMINUM RINGS. **REFLECTOR** - HEAVY WALL ALUMINUM CONSTRUCTION.

LENS ASS'Y: ONE PIECE HINGED HEAVY GAUGE DIE FORMED ALUMINUM DOOR FRAME SURROUNDS 3/16" CLEAR TEMPERED GLASS LENS. GLASS IS SEALED TO DOOR WITH HIGH TEMPERATURE SILICONE SEAL. CAPTIVE THUMB SCREW DISENGAGES LENS ASSEMBLY AND ACTIVATES ACCUHINGE™ TO ALLOW LENS ASSEMBLY TO HINGE AWAY FROM HOUSING FOR LUMINAIRE ACCESS WITHOUT THE USE OF TOOLS.

OPTICS: COMPUTER DESIGNED ONE PIECE SPECULAR SEGMENTED SIDE REFLECTORS COMBINE WITH AN AUXILIARY SPECULAR TOP REFLECTOR TO PRODUCE A HIGHLY EFFICIENT, SHARP CUTOFF. OPTICAL ASSEMBLY IS ROTATABLE IN 90° INCREMENTS.

GASKETING: CLOSED CELL EPDM GASKETING COMPRESSED BETWEEN DOOR AND HOUSING WORKS IN COMBINATION WITH ACCUHINGE™ TO PRESSURE SEAL OPTICAL CHAMBER.

LAMP HOLDER: MEDIUM OR MOGUL BASE PORCELAIN. LAMPHOLDER EQUIPPED WITH FACTORY INSTALLED QUICK DISCONNECT PLUG.

LAMP: (BY OTHERS)

BALLAST: H.P.F./C.W.A. AUTOTRANSFORMER. -20° STARTING TEMPERATURE. ELECTRICAL COMPONENTS ARE MOUNTED TO A REMOVABLE BALLAST TRAY. BALLAST IS EQUIPPED WITH FACTORY INSTALLED QUICK DISCONNECT PLUG.

FINISH: POLYESTER POWDER COAT-STATE OF THE ART 20 PSI PRESSURE POWER WASH AT 140° TEMPERATURE INCORPORATES FOUR STEP IRON PHOSPHATE PROCESS TO CLEANSE AND PRETREAT THE METAL SURFACE FOR MAXIMUM PAINT ADHESION. ELECTROSTATICALLY APPLIED TEXTURED POLYESTER POWDER TOPCOAT IS BAKED AT 400° TEMPERATURE FOR MAXIMUM HARDNESS AND EXTERIOR DURABILITY.



660 WEST AVENUE O, PALMDALE, CA. 93551
(661) 233-2000
FAX NO. (661) 233-2001
www.usaltg.com

MOUNTING STYLES

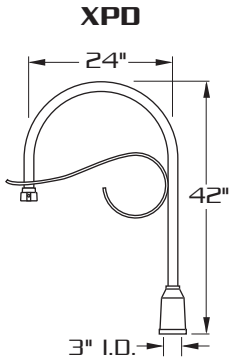
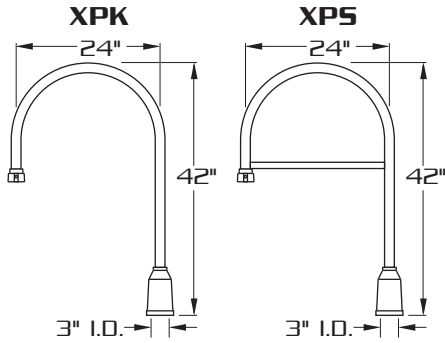

ARMS ARE HEAVY WALL EXTRUDED ALUMINUM CONSTRUCTION. FOR ADDITIONAL ARM OPTIONS SEE ARM SECTION.

WALL MOUNT

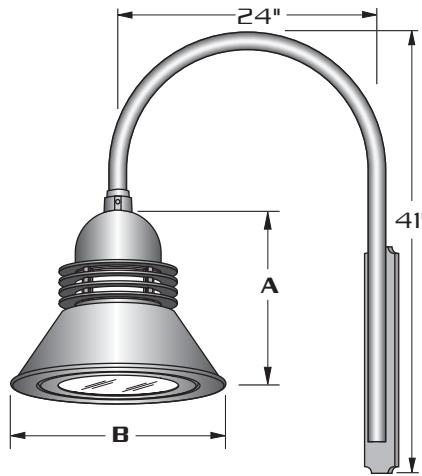

LUM.	A	B
DSCPM1	16 1/2"	20"
DSCPM25	24"	25"

EXTRUDED ALUMINUM ARM AND CAST ALUMINUM WALL BRACKET.

WALL PLATE

(4) 1/2" DIA. HOLES

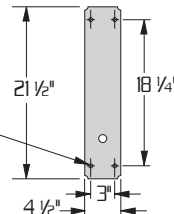

**LAMP SIZE:
50 - 250 WATT**

E.P.A. = 1.52

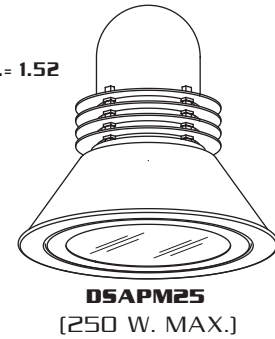

E.P.A. = 0.88

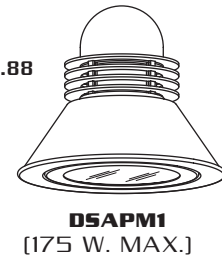

FOUR LIGHT DISTRIBUTIONS AVAILABLE.
OPTICAL SYSTEMS ENCLOSED IN IMPACT RESISTANT TEMPERED GLASS LENS.
REFLECTOR IS FIELD ROTATABLE.

ORDERING INFORMATION

MODEL NO. : DSAPM	OPTICS	WATTAGE TYPE VOLTAGE	MOUNTING	FINISH	OPTIONS
MODEL NO. :	OPTICS	LAMP	MOUNTING	FINISH	OPTIONS
DSAPM	<input type="checkbox"/> TYPE II HR-II (segmented, horizontal lamp)	<input type="checkbox"/> 250 <input type="checkbox"/> HPS <input type="checkbox"/> 120	<input type="checkbox"/> XPK <input type="checkbox"/> XPS	<input type="checkbox"/> DARK BRONZE DBM	<input type="checkbox"/> CONVEX GLASS..... DG
	<input type="checkbox"/> TYPE III HR-III (segmented, horizontal lamp)	<input type="checkbox"/> 175 <input type="checkbox"/> MH <input type="checkbox"/> 208	<input type="checkbox"/> XPD	<input type="checkbox"/> MEDIUM BRONZE MBM	<input type="checkbox"/> CLEAR CONVEX POLYCARBONATE DIFFUSER..... LEX
	<input type="checkbox"/> TYPE IV (FORWARD THROW) HR-IV (segmented, horizontal lamp)	<input type="checkbox"/> 150 <input type="checkbox"/> MV <input type="checkbox"/> 240	<input type="checkbox"/> WM.....	<input type="checkbox"/> BLACK BKM	<input type="checkbox"/> 3/4" IPS STEM MOUNT AND SWIVEL CANOPY (4'-0" MAX.)..... SM
	<input type="checkbox"/> TYPE V HR-V-SQ (segmented, horizontal lamp)	<input type="checkbox"/> 100 <input type="checkbox"/> 277	<input type="checkbox"/> 1.....	<input type="checkbox"/> WHITE WTM	<input type="checkbox"/> CHAIN MOUNTED (4'-0" MAX.)..... CM
		<input type="checkbox"/> 75 <input type="checkbox"/> 480		<input type="checkbox"/> SILVER SLM	<input type="checkbox"/> HOUSE SIDE SHIELD..... HS
	<input type="checkbox"/> 70 <input type="checkbox"/> MT			<input type="checkbox"/> QUARTZ RESTRIKE..... QTZ	
	<input type="checkbox"/> 50			<input type="checkbox"/> PHOTO CELL + VOLTAGE (EXAMPLE: PC120V)..... PC+V	
	DSAPM25 USE MOGUL BASE LAMPS		SEE ARM SECTION FOR ADDITIONAL ARMS	SEE PAGE 3 FOR ADDITIONAL COLORS	<input type="checkbox"/> SINGLE FUSE (120V., 277V)..... SF
	DSAPM1 USE MEDIUM BASE LAMPS				<input type="checkbox"/> DOUBLE FUSE (208V., 240V)..... DF

