

DSAP

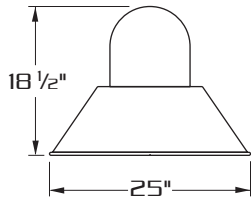

DSAP25
[250 WATT MAX.]

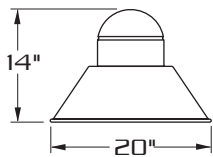

DSAP1
[175 WATT MAX.]

E.P.A. **DSAP25** = 1.23
DSAP1 = 0.77

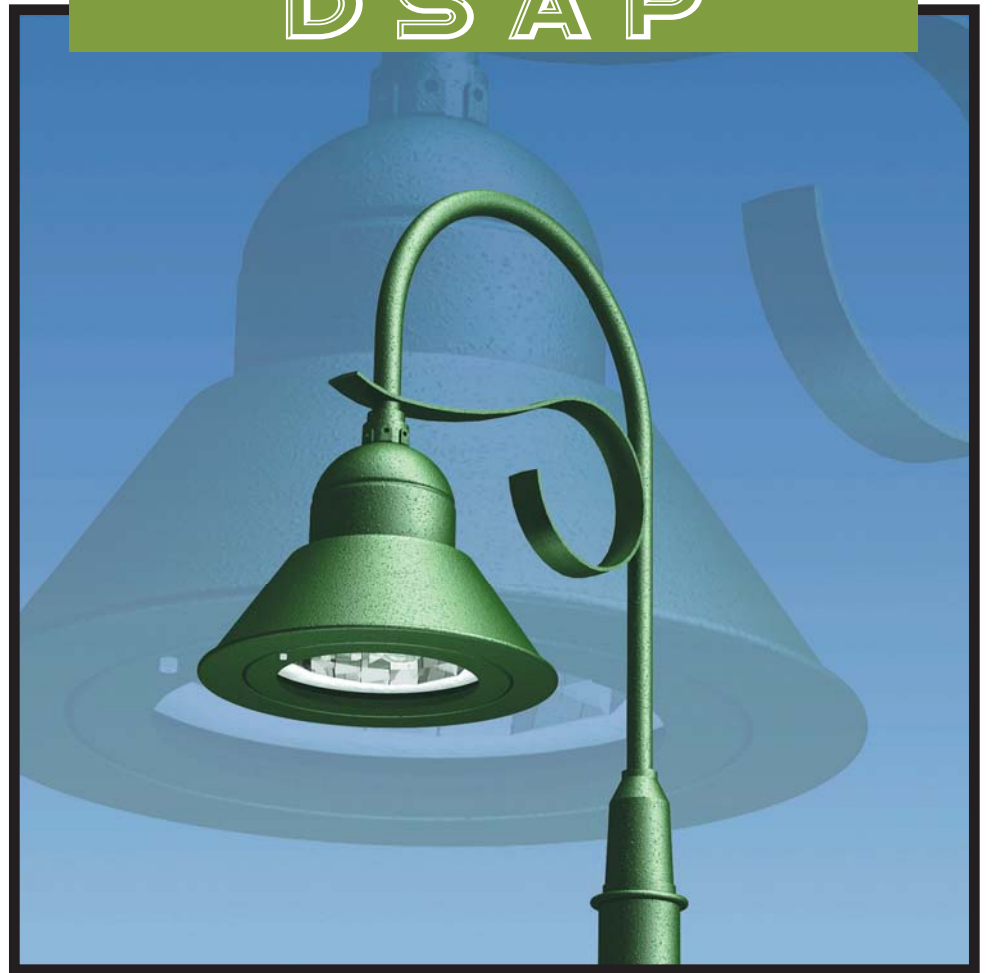

WM



1



2-180



2-90



3-90



3-120



4-90

SPECIFICATIONS

HOUSING: ONE PIECE HEAVY WALL ALUMINUM CONSTRUCTION WITH REMOVABLE BALLAST TRAY FOR EASY BALLAST ACCESS.

LENS ASS'Y: ONE PIECE HINGED HEAVY GAUGE DIE FORMED ALUMINUM DOOR FRAME SURROUNDS 3/16" CLEAR TEMPERED GLASS LENS. GLASS IS SEALED TO DOOR WITH HIGH TEMPERATURE SILICONE SEAL. CAPTIVE THUMB SCREW DISENGAGES LENS ASSEMBLY AND ACTIVATES ACCUHINGE™ TO ALLOW LENS ASSEMBLY TO HINGE AWAY FROM HOUSING FOR LUMINAIRE ACCESS WITHOUT THE USE OF TOOLS.

OPTICS: COMPUTER DESIGNED ONE PIECE SPECULAR SEGMENTED SIDE REFLECTORS COMBINE WITH AN AUXILIARY SPECULAR TOP REFLECTOR TO PRODUCE A HIGHLY EFFICIENT, SHARP CUTOFF. OPTICAL ASSEMBLY IS ROTATABLE IN 90° INCREMENTS.

GASKETING: CLOSED CELL EPDM GASKETING COMPRESSED BETWEEN DOOR AND HOUSING WORKS IN COMBINATION WITH ACCUHINGE™ TO PRESSURE SEAL OPTICAL CHAMBER.

LAMP HOLDER: MEDIUM OR MOGUL BASE PORCELAIN. LAMPHOLDER EQUIPPED WITH FACTORY INSTALLED QUICK DISCONNECT PLUG.

LAMP: (BY OTHERS)

BALLAST: H.P.F./C.W.A. AUTOTRANSFORMER, -20° STARTING TEMPERATURE. ELECTRICAL COMPONENTS ARE MOUNTED TO A REMOVABLE BALLAST TRAY. BALLAST IS EQUIPPED WITH FACTORY INSTALLED QUICK DISCONNECT PLUG.

FINISH: POLYESTER POWDER COAT-STATE OF THE ART 20 PSI PRESSURE POWER WASH AT 140° TEMPERATURE INCORPORATES FOUR STEP IRON PHOSPHATE PROCESS TO CLEANSE AND PRETREAT THE METAL SURFACE FOR MAXIMUM PAINT ADHESION. ELECTROSTATICALLY APPLIED TEXTURED POLYESTER POWDER TOPCOAT IS BAKED AT 400° TEMPERATURE FOR MAXIMUM HARDNESS AND EXTERIOR DURABILITY.



MOUNTING STYLES

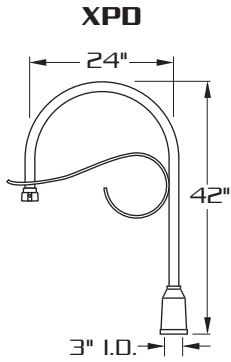
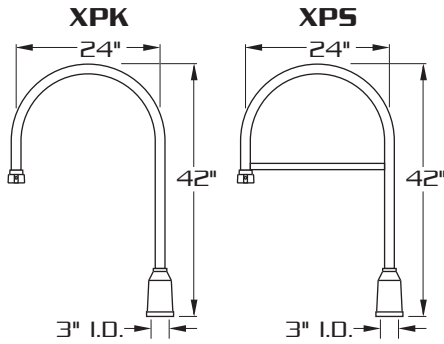

ARMS ARE HEAVY WALL EXTRUDED ALUMINUM CONSTRUCTION. FOR ADDITIONAL ARM OPTIONS SEE ARM SECTION.

WALL MOUNT

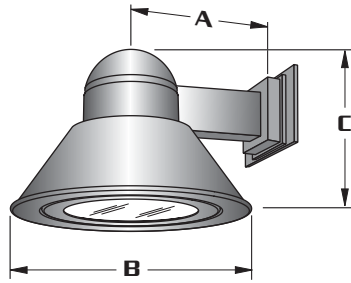

LUM.	A	B	C
DSAP1	14"	20"	14"
DSAP25	18"	25"	18 1/2"

EXTRUDED ALUMINUM ARM AND CAST ALUMINUM WALL BRACKET ASSEMBLY PROVIDED WITH BUILT IN GASKETED WIRE ACCESS FOR FIXTURE/SUPPLY WIRE CONNECTION.

WALL PLATE

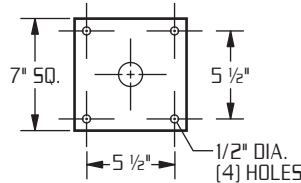

**LAMP SIZE:
50 - 250 WATT**

E.P.A. = 1.23

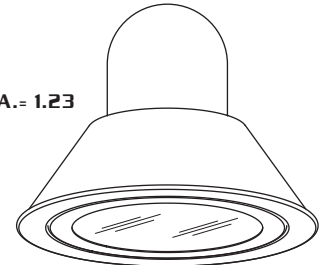

DSAP25
(250 WATT MAX.)

E.P.A. = 0.77

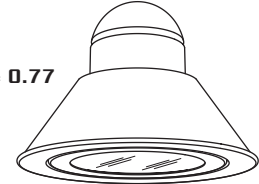

DSAP1
(175 WATT MAX.)

FOUR LIGHT DISTRIBUTIONS AVAILABLE.

OPTICAL SYSTEMS ENCLOSED IN IMPACT RESISTANT TEMPERED GLASS LENS.

REFLECTOR IS FIELD ROTATABLE.

ORDERING INFORMATION

MODEL NO. : DSAP	OPTICS	WATTAGE TYPE VOLTAGE	MOUNTING	FINISH	OPTIONS
MODEL NO. : DSAP	OPTICS	LAMP	MOUNTING	FINISH	OPTIONS
D S A P	HORIZONTAL LAMP REFLECTORS <input type="checkbox"/> TYPE II HR-II (segmented) <input type="checkbox"/> TYPE III HR-III (segmented) <input type="checkbox"/> TYPE IV (FORWARD THROW) HR-IV (segmented) <input type="checkbox"/> TYPE V HR-V-SQ (segmented)	<input type="checkbox"/> 250 <input type="checkbox"/> HPS <input type="checkbox"/> 120 <input type="checkbox"/> 175 <input type="checkbox"/> MH <input type="checkbox"/> 208 <input type="checkbox"/> 150 <input type="checkbox"/> MV <input type="checkbox"/> 240 <input type="checkbox"/> 100 <input type="checkbox"/> 277 <input type="checkbox"/> 75 <input type="checkbox"/> 480 <input type="checkbox"/> 70 <input type="checkbox"/> MT <input type="checkbox"/> 50	<input type="checkbox"/> XPK <input type="checkbox"/> XPS <input type="checkbox"/> XPD <input type="checkbox"/> WM <input type="checkbox"/> 1	<input type="checkbox"/> DARK BRONZE DBM <input type="checkbox"/> MEDIUM BRONZE MBM <input type="checkbox"/> BLACK BKM <input type="checkbox"/> WHITE WTM <input type="checkbox"/> SILVER SLM	<input type="checkbox"/> CONVEX GLASS..... DG <input type="checkbox"/> CLEAR CONVEX POLYCARBONATE DIFFUSER..... LEX <input type="checkbox"/> 3/4" IPS STEM MOUNT AND SWIVEL CANOPY (4'-0" MAX.)..... SM <input type="checkbox"/> CHAIN MOUNTED (4'-0" MAX.)..... CM <input type="checkbox"/> HOUSE SIDE SHIELD..... HS <input type="checkbox"/> QUARTZ RESTRIKE..... QTZ <input type="checkbox"/> PHOTO CELL + VOLTAGE (EXAMPLE: PC120V)..... PC+V <input type="checkbox"/> SINGLE FUSE (120V., 277V)..... SF <input type="checkbox"/> DOUBLE FUSE (208V., 240V)..... DF
	VERTICAL LAMP REFLECTORS <input type="checkbox"/> ASYMMETRIC VR-ASY (segmented) <input type="checkbox"/> TYPE V VR-V-SQ (segmented) VERTICAL LAMP REFLECTOR REQUIRES CONVEX GLASS	DSAP25 USE MOGUL BASE LAMPS DSAP1 USE MEDIUM BASE LAMPS	SEE ARM SECTION FOR ADDITIONAL ARMS	SEE PAGE 3 FOR ADDITIONAL COLORS	



660 WEST AVENUE O, PALMDALE, CA. 93551
 (661) 233-2000
 FAX NO. (661) 233-2001
 www.usaltg.com