

APOGEE-W19

[400 WATT MAX.]

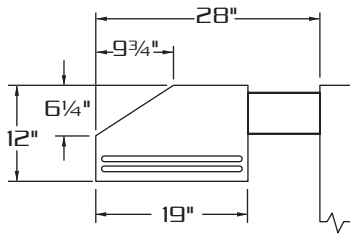

SIDE VIEW

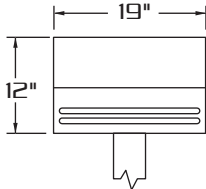

FRONT VIEW

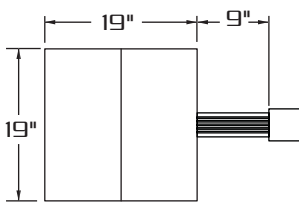

TOP VIEW

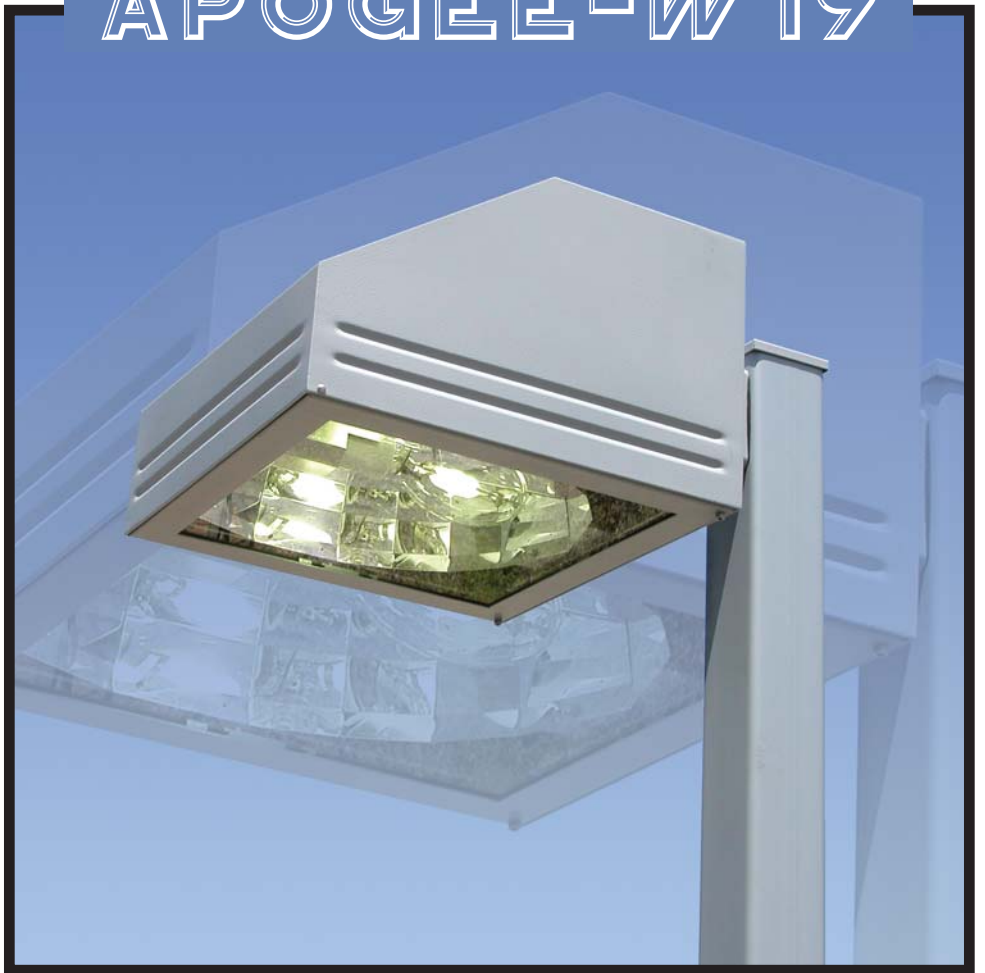

E.P.A. = 2.03



WM



1



2-180



2-90



3-90



3-120



4-90

SPECIFICATIONS

HOUSING: ONE PIECE HEAVY GAUGE DIE FORMED ALUMINUM CONSTRUCTION. HOUSING FURNISHED WITH DECORATIVE REVEALS TO PROVIDE CONTEMPORARY AESTHETICS. HOUSING REVEALS CAN BE SUPPLIED WITH ACCENT COLORS TO SIGNATURIZE INSTALLATION.

LENS ASSY: ONE PIECE HINGED HEAVY GAUGE DIE FORMED ALUMINUM DOOR FRAME SURROUNDS 3/16" CLEAR TEMPERED GLASS LENS. GLASS IS SEALED TO DOOR WITH HIGH TEMPERATURE SILICONE SEAL. TWO CAPTIVE THUMB SCREWS DISENGAGE LENS ASSEMBLY FROM HOUSING WITHOUT THE USE OF TOOLS.

OPTICS: COMPUTER DESIGNED ONE PIECE SPECULAR SEGMENTED REFLECTOR COMBINES WITH LENS TO PRODUCE A HIGHLY EFFICIENT, SHARP CUTOFF OR WIDE ANGLE LIGHT DISTRIBUTION. OPTICAL ASSEMBLY IS REMOVABLE WITHOUT USE OF TOOLS FOR ACCESS TO BALLAST TRAY. OPTICS ARE FIELD ROTATABLE IN 90° INCREMENTS.

GASKETING: CLOSED CELL EPDM GASKETING COMPRESSED BETWEEN DOOR AND HOUSING SEALS OPTICAL CHAMBER.

LAMP HOLDER: M06JUL BASE PORCELAIN. LAMP HOLDER EQUIPPED WITH FACTORY INSTALLED QUICK DISCONNECT PLUG.

LAMP: (BY OTHERS)

BALLAST: ELECTRICAL COMPONENTS ARE FACTORY PREWIRED WITH QUICK-DISCONNECT PLUGS AND ARE MOUNTED TO A REMOVABLE BALLAST TRAY. ENTIRE BALLAST ASSEMBLY IS REMOVABLE FROM HOUSING WITHOUT USE OF TOOLS.

ARM: 3"X5"X9" HEAVY WALL EXTRUDED ALUMINUM. ARM IS DESIGNED WITH HORIZONTAL RIBS TO COMPLIMENT STYLING ON HOUSING.

HARDWARE: ALL EXPOSED HARDWARE IS STAINLESS STEEL.

FINISH: POLYESTER POWDER COAT-STATE OF THE ART 20 PSI PRESSURE POWER WASH AT 140° TEMPERATURE INCORPORATES FOUR STEP IRON PHOSPHATE PROCESS TO CLEANSE AND PRETREAT THE METAL SURFACE FOR MAXIMUM PAINT ADHESION. ELECTROSTATICALLY APPLIED TEXTURED POLYESTER POWDER TOP COAT IS BAKED AT 400° TEMPERATURE FOR MAXIMUM HARDNESS AND EXTERIOR DURABILITY.



660 WEST AVENUE O, PALMDALE, CA. 93551
 (661) 233-2000
 FAX NO. (661) 233-2001
www.usaltg.com

A12-11

TYPICAL SQUARE POLE TEMPLATE

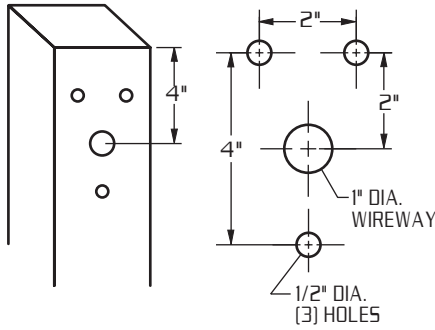

TYPICAL ROUND POLE TEMPLATE

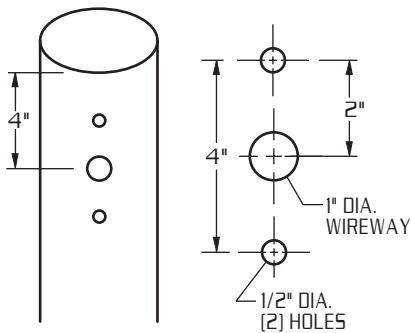

WALL MOUNT

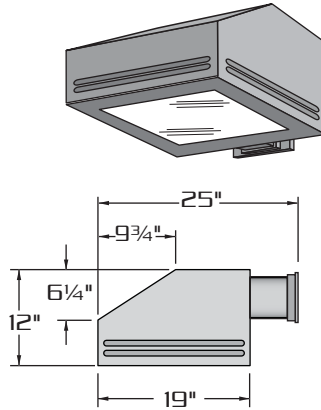

FACTORY INSTALLED EXTRUDED ALUMINUM ARM SECURED TO CAST ALUMINUM WALL BRACKET. ARM IS PROVIDED WITH BUILT IN GASKETED WIRE ACCESS FOR FIXTURE/SUPPLY WIRE CONNECTION.

WALL PLATE

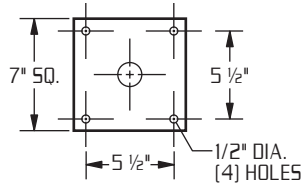

**LAMP SIZE:
150 - 400 WATT**

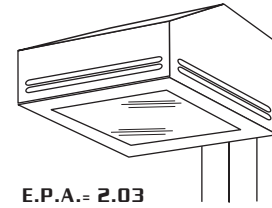

RECTILINEAR HEAVY GAUGE ALUMINUM HOUSING.

FIELD ROTATABLE OPTICS.

SHARP CUTOFF HORIZONTAL AND WIDE ANGLE VERTICAL LAMP OPTICS.

TOOLESS LAMP AND BALLAST ACCESS.

TOOLESS REMOVABLE BALLAST TRAY PROVIDED WITH QUICK DISCONNECT PLUG FOR EASY SERVICING.

ORDERING INFORMATION

MODEL NO. : APG-W19	OPTICS	WATTAGE	TYPE	VOLTAGE	MOUNTING	FINISH	OPTIONS					
APG-W19	HORIZONTAL LAMP	WATTAGE	TYPE	VOLTAGE	ARM MOUNT	<input type="checkbox"/> DARK BRONZE DBM <input type="checkbox"/> MEDIUM BRONZE MBM <input type="checkbox"/> BLACK BKM <input type="checkbox"/> WHITE WTM <input type="checkbox"/> SILVER SLM	<input type="checkbox"/> CLEAR TEMPERED CONVEX GLASS LENS CCG <input type="checkbox"/> CLEAR POLYCARBONATE DIFFUSER LEX <input type="checkbox"/> HOUSE SIDE SHIELD HS <input type="checkbox"/> PHOTO CELL + VOLTAGE (EXAMPLE: PC120V) PC+V <input type="checkbox"/> TWIST LOCK PHOTO CELL+VOLTAGE (EXAMPLE TPC120V) TPC+V <input type="checkbox"/> TWIST LOCK RECEPTACLE ONLY TPR <input type="checkbox"/> SINGLE FUSE (120V. , 277V) SF <input type="checkbox"/> DOUBLE FUSE (208V. , 240V) DF					
	<input type="checkbox"/> TYPE II HR-II	<input type="checkbox"/> 400	<input type="checkbox"/> HPS	<input type="checkbox"/> 120	<input type="checkbox"/> 1			<input type="checkbox"/> ST 23 (TO FIT OVER 2 3/8" O.D. ARM)				
	<input type="checkbox"/> TYPE III HR-III	<input type="checkbox"/> 250	<input type="checkbox"/> MH	<input type="checkbox"/> 208	<input type="checkbox"/> ADJUSTABLE KNUCKLE <input type="checkbox"/> NKLE23 (TO FIT OVER 2 3/8" O.D.)							
	<input type="checkbox"/> TYPE IV-W HR-IV-W ...	<input type="checkbox"/> 200	<input type="checkbox"/> MHPS	<input type="checkbox"/> 240					<input type="checkbox"/> NKLE27 (TO FIT OVER 2 7/8" O.D.)			
	<input type="checkbox"/> TYPE V HR-V-SQ	<input type="checkbox"/> 175	<input type="checkbox"/> MV	<input type="checkbox"/> 277						<input type="checkbox"/> WALL MOUNT <input type="checkbox"/> WM		
	<input type="checkbox"/> TYPE FT (REAR CUTOFF) HR-FT-HSC ...	<input type="checkbox"/> 150	<input type="checkbox"/> MT	<input type="checkbox"/> 480							SEE PAGE 3 FOR ADDITIONAL COLORS	
	VERTICAL LAMP	MH and MHPS USE ED28 LAMP FOR 400 W.										
	<input type="checkbox"/> TYPE III VR-III	*175 W. MHPS AVAILABLE FOR VERTICAL LAMP ONLY										
	<input type="checkbox"/> TYPE V VR-V-SQ											