

# APOGEE-W19

[400 WATT MAX.]

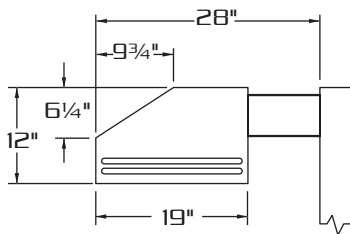

**SIDE VIEW**

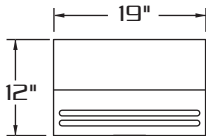

**FRONT VIEW**

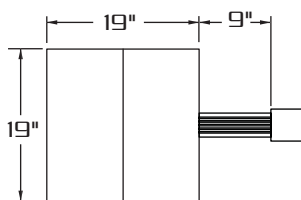

**TOP VIEW**

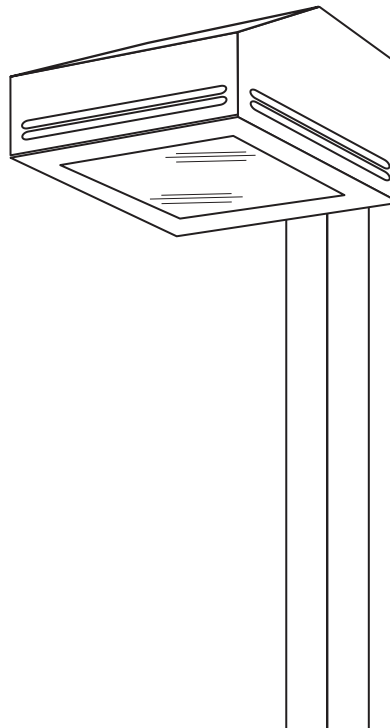

E.P.A. = 2.03



WM



1



2-180



2-90



3-90



3-120



4-90

## SPECIFICATIONS

**HOUSING:** ONE PIECE HEAVY GAUGE DIE FORMED ALUMINUM CONSTRUCTION. HOUSING FURNISHED WITH DECORATIVE REVEALS TO PROVIDE CONTEMPORARY AESTHETICS. HOUSING REVEALS CAN BE SUPPLIED WITH ACCENT COLORS TO SIGNATURIZE INSTALLATION.

**LENS ASS'Y:** ONE PIECE HINGED HEAVY GAUGE DIE FORMED ALUMINUM DOOR FRAME SURROUNDS 3/16" CLEAR TEMPERED GLASS LENS. GLASS IS SEALED TO DOOR WITH HIGH TEMPERATURE SILICONE SEAL. TWO CAPTIVE THUMB SCREWS DISENGAGE LENS ASSEMBLY FROM HOUSING WITHOUT THE USE OF TOOLS.

**OPTICS:** COMPUTER DESIGNED SPECULAR SEGMENTED OPTICAL ASSEMBLIES PROVIDE HIGHLY UNIFORM, WIDE THROW LIGHT DISTRIBUTIONS. BOTH HORIZONTAL AND VERTICAL LAMP OPTICS PROVIDED WITH STANDARD FLAT GLASS LENS FOR FULL CUTOFF LIGHT DISTRIBUTIONS. VERTICAL LAMP OPTICS ARE ALSO AVAILABLE WITH OPTIONAL SAG GLASS LENS. OPTICAL ASSEMBLIES ARE BOTH FIELD ROTATABLE IN 90° DEGREE INCREMENTS AND REMOVABLE FOR BALLAST TRAY ACCESS WITHOUT THE USE OF TOOLS.

**GASKETING:** CLOSED CELL EPDM GASKETING COMPRESSED BETWEEN DOOR AND HOUSING SEALS OPTICAL CHAMBER.

**LAMP HOLDER:** MOGUL BASE PORCELAIN. LAMP HOLDER EQUIPPED WITH FACTORY INSTALLED QUICK DISCONNECT PLUG.

**LAMP:** (BY OTHERS)

**BALLAST:** ELECTRICAL COMPONENTS ARE FACTORY PREWIRED WITH QUICK-DISCONNECT PLUGS AND ARE MOUNTED TO A REMOVABLE BALLAST TRAY. ENTIRE BALLAST ASSEMBLY IS REMOVABLE FROM HOUSING WITHOUT USE OF TOOLS.

**ARM:** 3"X5"X9" HEAVY WALL EXTRUDED ALUMINUM. ARM IS DESIGNED WITH HORIZONTAL RIBS TO COMPLIMENT STYLING ON HOUSING.

**HARDWARE:** ALL EXPOSED HARDWARE IS STAINLESS STEEL.

**FINISH:** POLYESTER POWDER COAT-STATE OF THE ART 20 PSI PRESSURE POWER WASH AT 140° TEMPERATURE INCORPORATES FOUR STEP IRON PHOSPHATE PROCESS TO CLEANSE AND PRETREAT THE METAL SURFACE FOR MAXIMUM PAINT ADHESION. ELECTROSTATICALLY APPLIED TEXTURED POLYESTER POWDER TOP COAT IS BAKED AT 400° TEMPERATURE FOR MAXIMUM HARDNESS AND EXTERIOR DURABILITY.



660 WEST AVENUE O, PALMDALE, CA. 93551  
 (661) 233-2000  
 FAX NO. (661) 233-2001  
[www.usaltg.com](http://www.usaltg.com)

A12-11

**TYPICAL SQUARE POLE TEMPLATE**

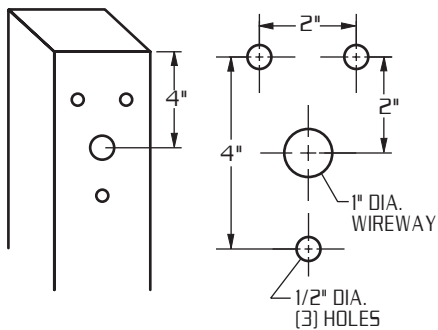

**TYPICAL ROUND POLE TEMPLATE**

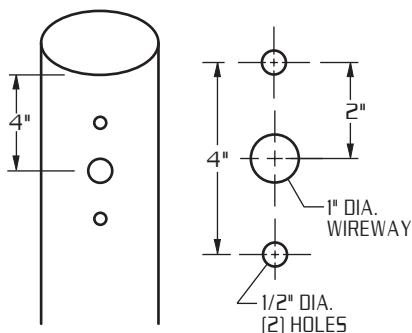

**WALL MOUNT**

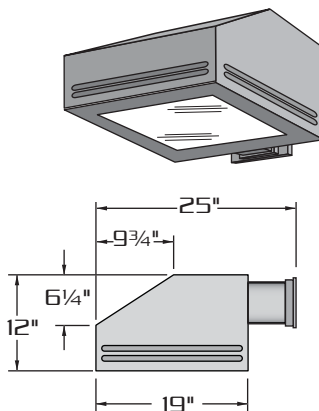

FACTORY INSTALLED EXTRUDED ALUMINUM ARM SECURED TO CAST ALUMINUM WALL BRACKET. ARM IS PROVIDED WITH BUILT IN GASKETED WIRE ACCESS FOR FIXTURE/SUPPLY WIRE CONNECTION.

**WALL PLATE**

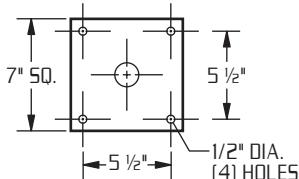

**LAMP SIZE:  
150 - 400 WATT**

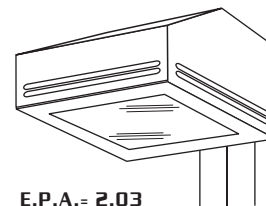

**RECTILINEAR HEAVY GAUGE ALUMINUM HOUSING.**

**FIELD ROTATABLE OPTICS.**

**SHARP CUTOFF HORIZONTAL AND WIDE ANGLE VERTICAL LAMP OPTICS.**

**TOOLESS LAMP AND BALLAST ACCESS.**

**TOOLESS REMOVABLE BALLAST TRAY PROVIDED WITH QUICK DISCONNECT PLUG FOR EASY SERVICING.**

**ORDERING INFORMATION**

MODEL NO.:	OPTICS	WATTAGE	TYPE	VOLTAGE	MOUNTING	FINISH	OPTIONS
APG-W19							

MODEL NO.:	OPTICS	LAMP	MOUNTING	FINISH	OPTIONS
<b>A P G - W 1 9</b>	<b>HORIZONTAL LAMP</b> <input type="checkbox"/> TYPE II <b>HR-II</b> ..... <input type="checkbox"/> TYPE III <b>HR-III</b> ..... <input type="checkbox"/> TYPE IV-W <b>HR-IV-W</b> ..... <input type="checkbox"/> TYPE V <b>HR-V-SQ</b> ..... <input type="checkbox"/> TYPE FT (REAR CUTOFF) <b>HR-FT-HSC</b> .....  <b>VERTICAL LAMP</b> <input type="checkbox"/> TYPE III <b>VR-III</b> ..... <input type="checkbox"/> TYPE V <b>VR-V-SQ</b> .....	<b>WATTAGE</b> <input type="checkbox"/> 400 <input type="checkbox"/> 250 <input type="checkbox"/> 200 <input type="checkbox"/> 175 <input type="checkbox"/> 150 <b>TYPE</b> <input type="checkbox"/> HPS <input type="checkbox"/> MH <input type="checkbox"/> PSMH <input type="checkbox"/> MV <input type="checkbox"/> MT <b>VOLTAGE</b> <input type="checkbox"/> 120 <input type="checkbox"/> 208 <input type="checkbox"/> 240 <input type="checkbox"/> 277 <input type="checkbox"/> 480  <b>MH and MHPS</b> USE ED28 LAMP FOR 400 W.  *175 W. MHPS AVAILABLE FOR VERTICAL LAMP ONLY	<b>ARM MOUNT</b> <input type="checkbox"/> 1 .....  <b>STREET LIGHTING ARM MOUNT</b> <input type="checkbox"/> <b>ST 23</b> ..... (TO FIT OVER 2 3/8" O.D. ARM)  <b>ADJUSTABLE KNUCKLE</b> <input type="checkbox"/> <b>NKLE23</b> ..... (TO FIT OVER 2 3/8" O.D.) <input type="checkbox"/> <b>NKLE27</b> ..... (TO FIT OVER 2 7/8" O.D.)  <b>WALL MOUNT</b> <input type="checkbox"/> <b>WM</b> .....	<input type="checkbox"/> DARK BRONZE <b>DBM</b> <input type="checkbox"/> MEDIUM BRONZE <b>MBM</b> <input type="checkbox"/> BLACK <b>BKM</b> <input type="checkbox"/> WHITE <b>WTM</b> <input type="checkbox"/> SILVER <b>SLM</b>  SEE PAGE 3 FOR ADDITIONAL COLORS	<input type="checkbox"/> CLEAR TEMPERED CONVEX GLASS LENS ..... <b>CCG</b> <input type="checkbox"/> CLEAR POLYCARBONATE DIFFUSER ..... <b>LEX</b> <input type="checkbox"/> HOUSE SIDE SHIELD ..... <b>HS</b>  <input type="checkbox"/> PHOTO CELL + VOLTAGE (EXAMPLE: PC120V) ..... <b>PC+V</b> <input type="checkbox"/> TWIST LOCK PHOTO CELL+VOLTAGE (EXAMPLE TPC120V) ..... <b>TPC+V</b> <input type="checkbox"/> TWIST LOCK RECEPTACLE ONLY ..... <b>TPR</b>  <input type="checkbox"/> SINGLE FUSE (120V. , 277V) ..... <b>SF</b> <input type="checkbox"/> DOUBLE FUSE (208V. , 240V) ..... <b>DF</b>