

AEROLUME™

[400 WATT MAX.]

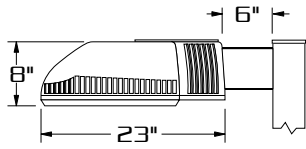

SIDE VIEW

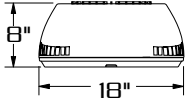

FRONT VIEW

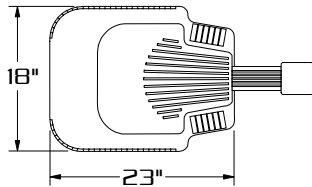

TOP VIEW

E.P.A.= 1.40

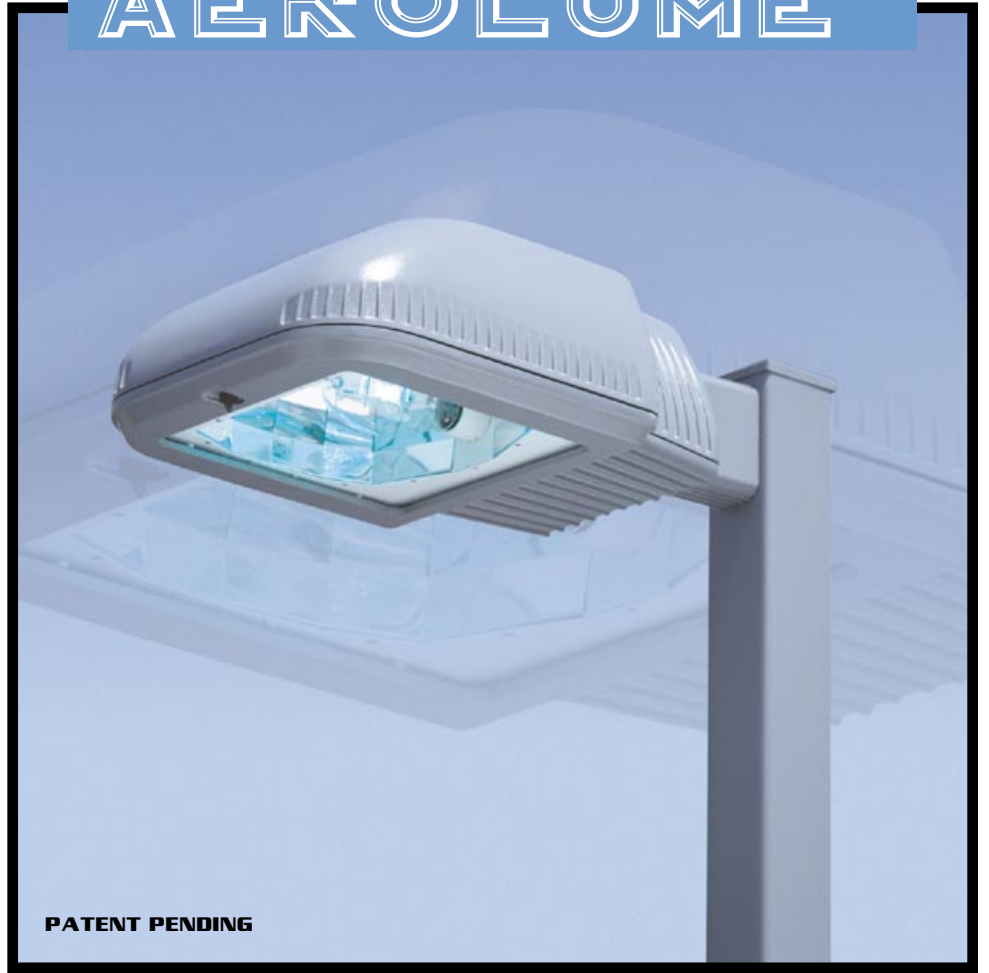

PATENT PENDING



WM



1



2-180



2-90



3-90



3-120



4-90

SPECIFICATIONS

HOUSING: PRECISE, ONE PIECE CAST ALUMINUM CONSTRUCTION. AERODYNAMIC STYLING OF HOUSING AND BALLAST COMPARTMENT FEATURES RIBBED DETAILS WHICH DISSIPATES HEAT FROM LUMINAIRE INTERIOR TO INCREASE BOTH BALLAST AND LAMP LIFE.

LENS ASS'Y: PRECISE, ONE PIECE CAST ALUMINUM CONSTRUCTION. DOOR FRAME ENCASES 3/16" CLEAR TEMPERED GLASS LENS SEALED TO DOOR FRAME WITH HIGH TEMPERATURE EPDM GASKET TO COMPLETELY SEAL DOOR FRAME FROM CONTAMINANTS. QUARTER TURN FASTENER DISENGAGES LENS ASSEMBLY AND ACTIVATES ACCULATCH™ HINGE TO ALLOW LENS ASSEMBLY TO HINGE AWAY FROM HOUSING FOR LUMINAIRE ACCESS WITHOUT THE USE OF TOOLS.

OPTICS: COMPUTER DESIGNED ONE PIECE SPECULAR SEGMENTED SIDE REFLECTORS COMBINE WITH AN AUXILIARY HAMMERED PATTERNED TOP REFLECTOR TO PRODUCE A HIGHLY EFFICIENT, SHARP CUTOFF. OPTICAL ASSEMBLY IS ROTATABLE IN 90° INCREMENTS.

GASKETING: CLOSED CELL EPDM GASKETING COMPRESSED BETWEEN DOOR AND HOUSING WORKS IN COMBINATION WITH ACCULATCH™ HINGE TO PRESSURE SEAL OPTICAL CHAMBER.

LAMP HOLDER: M06UL BASE PORCELAIN. LAMPHOLDER EQUIPPED WITH FACTORY INSTALLED QUICK DISCONNECT PLUG.

LAMP: (BY OTHERS)

BALLAST: ELECTRICAL COMPONENTS ARE FACTORY PREWIRED WITH QUICK-DISCONNECT PLUGS, AND ARE MOUNTED TO A ONE PIECE HINGED BALLAST PLATE. BALLAST PLATE DISENGAGES FROM HOUSING WITHOUT USE OF TOOLS. BALLAST PLATE HINGES AND IS REMOVABLE FOR SERVICING.

ARM: 3"X5"X6" LONG HEAVY WALL EXTRUDED ALUMINUM. ARM IS DESIGNED WITH SOFT CORNERS AND HORIZONTAL RIBS TO COMPLIMENT STYLING ON HOUSING AND DOOR FRAME.

HARDWARE: ALL EXPOSED HARDWARE IS STAINLESS STEEL.

FINISH: POLYESTER POWDER COAT-STATE OF THE ART 20 PSI PRESSURE POWER WASH AT 140° TEMPERATURE INCORPORATES FOUR STEP IRON PHOSPHATE PROCESS TO CLEANSE AND PRETREAT THE METAL SURFACE FOR MAXIMUM PAINT ADHESION. ELECTROSTATICALLY APPLIED TEXTURED POLYESTER POWDER TOP COAT IS BAKED AT 400° TEMPERATURE FOR MAXIMUM HARDNESS AND EXTERIOR DURABILITY.



660 WEST AVENUE O, PALMDALE, CA. 93551

(661) 233-2000

FAX NO. (661) 233-2001

www.usaltg.com

A1-1

TYPICAL SQUARE POLE TEMPLATE

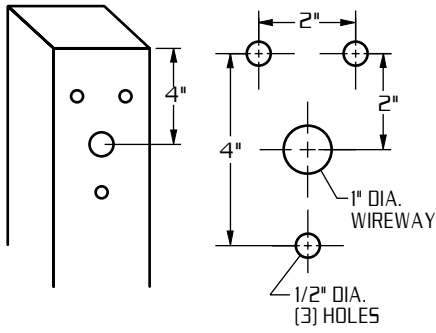

TYPICAL ROUND POLE TEMPLATE

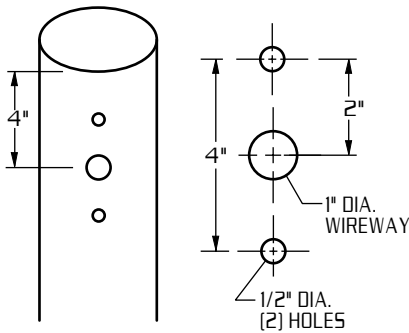

WALL MOUNT

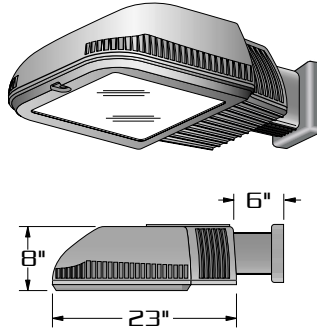

EXTRUDED ALUMINUM ARM AND CAST ALUMINUM WALL BRACKET ASSEMBLY PROVIDED WITH BUILT IN GASKETED WIRE ACCESS FOR FIXTURE/SUPPLY WIRE CONNECTION.

WALL PLATE

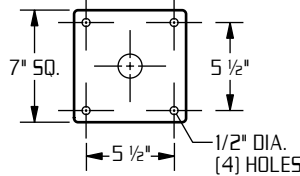

**LAMP SIZE:
100 - 400 WATT**

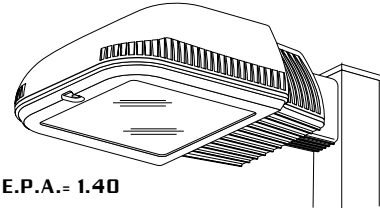

E.P.A.= 1.40

PATENT PENDING

PRECISE CAST ALUMINUM HOUSING AND DOOR FRAME.

OPTICAL SYSTEM ENCLOSED IN IMPACT RESISTANT TEMPERED GLASS LENS.

REFLECTOR IS ENTIRELY FIELD ROTATABLE.

TOOLESS ENTRY TO LUMINAIRE HOUSING.

BALLAST TRAY IS HINGED AND REMOVABLE WITHOUT THE USE OF TOOLS FOR EASY ACCESS TO ELECTRICAL COMPONENTS.

ORDERING INFORMATION

| MODEL NO.: | OPTICS | WATTAGE TYPE VOLTAGE | MOUNTING | FINISH | OPTIONS |
|------------|--|---|--|--|---|
| AER | | | | | |
| MODEL NO.: | OPTICS | LAMP | MOUNTING | FINISH | OPTIONS |
| AER | <input type="checkbox"/> TYPE I I..... (hydroform) | <input type="checkbox"/> 400 <input type="checkbox"/> HPS <input type="checkbox"/> 120 | ARM MOUNT | <input type="checkbox"/> DARK BRONZE DBM | <input type="checkbox"/> CLEAR POLYCARBONATE DIFFUSER LEX |
| | <input type="checkbox"/> TYPE II II..... (hydroform) | <input type="checkbox"/> 250 <input type="checkbox"/> MH <input type="checkbox"/> 208 | <input type="checkbox"/> 1 <input type="checkbox"/> | <input type="checkbox"/> MEDIUM BRONZE MBM | <input type="checkbox"/> HOUSE SIDE SHIELD HS |
| | <input type="checkbox"/> TYPE III III..... (segmented) | <input type="checkbox"/> 200 <input type="checkbox"/> MV <input type="checkbox"/> 240 | STREET LIGHTING ARM MOUNT | <input type="checkbox"/> BLACK BKM | <input type="checkbox"/> PHOTO CELL + VOLTAGE (EXAMPLE: PC120V) PC+V |
| | <input type="checkbox"/> TYPE IV IV..... (segmented) | <input type="checkbox"/> 175 <input type="checkbox"/> 277 | <input type="checkbox"/> ST 23 <input type="checkbox"/> | <input type="checkbox"/> WHITE WTM | <input type="checkbox"/> TWIST LOCK PHOTO CELL+VOLTAGE (EXAMPLE TPC120V) TPC+V |
| | <input type="checkbox"/> TYPE V V-SQ... (segmented) | <input type="checkbox"/> 150 <input type="checkbox"/> 480 | <input type="checkbox"/> NKLE23 <input type="checkbox"/> | <input type="checkbox"/> SILVER SLM | <input type="checkbox"/> TWIST LOCK RECEPTACLE ONLY TPR |
| | <input type="checkbox"/> 100 <input type="checkbox"/> MT | <input type="checkbox"/> NKLE27 <input type="checkbox"/> | ADJUSTABLE KNUCKLE | <input type="checkbox"/> SINGLE FUSE (120V., 277V) SF | |
| | | | <input type="checkbox"/> NKLE23 <input type="checkbox"/> | <input type="checkbox"/> DOUBLE FUSE (208V., 240V) DF | |
| | | | <input type="checkbox"/> NKLE27 <input type="checkbox"/> | | |
| | | | WALL MOUNT | | |
| | | | <input type="checkbox"/> WM <input type="checkbox"/> | | |
| | | | | SEE PAGE 3 FOR ADDITIONAL COLORS | |
| | | METAL HALIDE UNITS ONLY USE ED28 LAMP FOR 400 W. USE MEDIUM BASE LAMP FOR 100 W. | | | |



660 WEST AVENUE O, PALMDALE, CA. 93551
(661) 233-2000
FAX NO. (661) 233-2001
www.usaltg.com