

H.I.D. AREA LIGHTING

XTS19 SERIES-HID

S P E C I F I C A T I O N S

HOUSING and ARM

One-piece continuous extruded aluminum side panels folded and mitered at the corners. Formed cover interlocks with side panels to make all weathertight. Arm is 3" x 5" x 9" long heavy wall extruded aluminum designed with soft corners and horizontal ribs to compliment housing. All exposed hardware is stainless steel. Internal hardware is electro-zinc plated steel.

LENS ASSEMBLY

One piece cast extruded construction. door frame encased 3/16" clear tempered glass lens sealed to door frame with high temperature EDPM gasketing to completely seal door frame from contaminants. Quarter turn fastener disengages lens assembly and activate Acculatch™ hinge to allow lens assemble to hinge away from housing for luminaire access without the use of tools. Closed cell EDPM gasketing compresses between door and housing works in combination with Acculatch™ hinge to pressure seal optical chamber.

OPTICS

Computer designed one piece specular segmented side reflectors combine with a specular auxiliary top reflector to produce a highly efficient sharp cutoff. Precision design optical assembly provides uniform wide throw light distribution. Optical assembly is rotatable in 90° increments. Sockets are porcelain 4KV pulse rated, medium base (E26) for 50W - 150W; pin oriented mogul base (E39) for 250W - 400W. Special for 210W and 315W CDM Elite lamp base is PGZ18. Lamp is horizontally mounted.

ELECTRICAL COMPONENTS

All electrical components are UL and cUL recognized are factory prewired with quick-disconnecting plugs and are mounted to a one piece hinged ballast plate. Ballast plate hinges and is removable for servicing. Ballast plate disengages from housing without use of tools. Electronic MH ballasts have power factor of >.95, -20°F starting, 120-277V 50Hz/60Hz and have lamp End-of-life protection. Special for Philips MasterColor CDM Elite: Electronic MH ballast has a power factor of >.90 (210W & 315W), -4°F starting, 200 - 277V, 50Hz/60Hz and has lamp End-of-life protection. 315W electronic MH ballast has 0 - 10V dimming capability. Magnetic MH ballasts are high power factor (70W - 150W) or CWA (250W), -20°F starting, multi-tap 120-277V, 60Hz. All HPS ballasts are core and coil, high-reactance, high power factor (70W - 150W) or CWA (200W - 250W), -40°F starting.

FINISH

Electrostatically applied TGIC Polyester Powder Coat on substrate prepared with 20 PSI power wash at 140°F. Four step iron phosphate pretreatment for protection and paint adhesion. 400°F bake for maximum hardness and durability. Texture finish is standard.

PROJECT NAME: _____

FIXTURE TYPE: _____



XTS19

PATENT PENDING

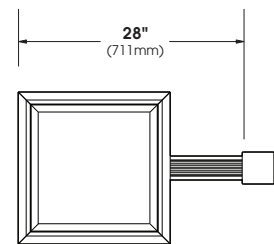

TOP VIEW

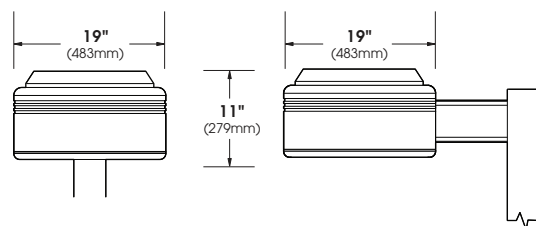

FRONT VIEW

SIDE VIEW

 Light Pollution Control Classification System
Full cutoff 0% Uplight Luminaire

 U.L. Listed for wet location

MADE IN THE

2014303

U.S. Architectural Lighting

660 West Avenue O, Palmdale, CA 93551
Phone (661) 233-2000 Fax (661) 233-2001
www.usallg.com



XTS19 SERIES - HID

S P E C I F I C A T I O N S

POLE DRILLING TEMPLATE

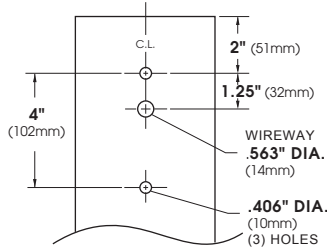

OVERVIEW

PRECISE EXTRUDED ALUMINUM HOUSING AND DOOR FRAME.

OPTICAL SYSTEM ENCLOSED IN IMPACT RESISTANT TEMPERED GLASS LENS.

REFLECTOR IS ENTIRELY FIELD ROTATABLE.

TOOLESS ENTRY TO LUMINAIRE HOUSING.

BALLAST TRAY IS HINGED AND REMOVABLE WITHOUT THE USE OF TOOLS FOR EASY ACCESS TO ELECTRICAL COMPONENTS.

WALL MOUNT

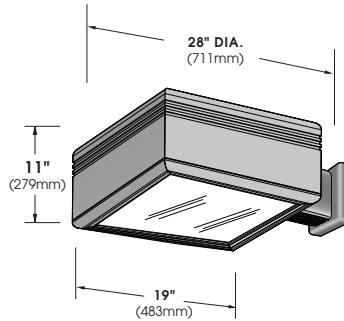

EXTRUDED ALUMINUM ARM AND CAST ALUMINUM WALL BRACKET ASSEMBLY PROVIDED WITH BUILT IN GASKETED WIRE ACCESS FOR FIXTURE/SUPPLY WIRE CONNECTION.

WALL PLATE

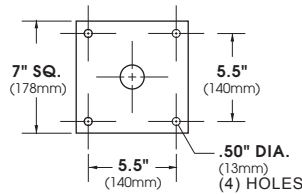

E.P.A. & LAMP WATTAGE

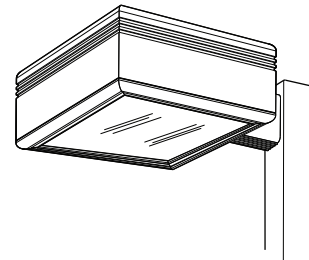

XTS19 E.P.A. = 1.83
LAMP SIZE: 100 - 400 WATT

Spec/Order Example: XTS19/HR-III/250HPS277/1/RAL-9003-S/TPR

S P E C / O R D E R I N G I N F O R M A T I O N

MODEL	OPTICS	WATTAGE	TYPE	VOLTAGE	MOUNTING	FINISH	OPTIONS
MODEL	OPTICS	LAMP			MOUNTING	FINISH	OPTIONS
	HORIZONTAL LAMP REFLECTORS	WATTAGE	TYPE	VOLTAGE	ARM MOUNT	STANDARD TEXTURED FINISH	
<input type="checkbox"/> XTS19	<input type="checkbox"/> TYPE II HR-II <input type="checkbox"/> TYPE III HR-III <input type="checkbox"/> TYPE IV HR-IV (FORWARD THROW) <input type="checkbox"/> TYPE V-SQ HR-V-SQ ...	<input type="checkbox"/> 400 ³ <input type="checkbox"/> 350 ³ <input type="checkbox"/> 320 ³ <input type="checkbox"/> 315 ⁴ <input type="checkbox"/> 250 <input type="checkbox"/> 210 ⁴ <input type="checkbox"/> 200 ² <input type="checkbox"/> 175 ² <input type="checkbox"/> 150 <input type="checkbox"/> 100 <input type="checkbox"/> E ¹ (ELECTRONIC)	<input type="checkbox"/> PSMH <input type="checkbox"/> HPS	<input type="checkbox"/> 120 <input type="checkbox"/> 208 <input type="checkbox"/> 240 <input type="checkbox"/> 277 <input type="checkbox"/> 347 (CAN) <input type="checkbox"/> 480	<input type="checkbox"/> 1 <input type="checkbox"/> 2-180 <input type="checkbox"/> 2-90 <input type="checkbox"/> 3-90 <input type="checkbox"/> 3-120 <input type="checkbox"/> 4-90 ADJUSTABLE KNUCKLE FITTER <input type="checkbox"/> NKLE27 <input type="checkbox"/> NKLE23 WALL MOUNT <input type="checkbox"/> WM	<input type="checkbox"/> BLACK RAL-9005-T <input type="checkbox"/> WHITE RAL-9003-T <input type="checkbox"/> GREY RAL-7004-T <input type="checkbox"/> DARK BRONZE RAL-8019-T <input type="checkbox"/> GREEN RAL-6005-T FOR SMOOTH FINISH REPLACE SUFFIX "T" WITH SUFFIX "S" (EXAMPLE: RAL-9005-S) SEE USALTG.COM FOR ADDITIONAL COLORS	<input type="checkbox"/> CLEAR POLYCARBONATE DIFFUSER LEX <input type="checkbox"/> HOUSE SIDE SHIELD HS <input type="checkbox"/> PHOTO CELL + VOLTAGE (EXAMPLE: PC120V) PC+V <input type="checkbox"/> TWIST LOCK PHOTO CELL+VOLTAGE (EXAMPLE TPC120V) TPC+V <input type="checkbox"/> TWIST LOCK RECEPTACLE ONLY. TPR <input type="checkbox"/> SINGLE FUSE (120V., 277V) SF <input type="checkbox"/> DOUBLE FUSE (208V., 240V) DF
		NOTES: 1 - 120-277V ONLY 2 - POSITION SENSITIVE LAMP 3 - "E" BALLAST NOT AVAILABLE 4 - PG218 BASE					CONSULT FACTORY FOR DIMMING APPLICATIONS
		CONSULT FACTORY FOR OTHER BALLAST CONFIGURATIONS AND LAMP OPTIONS					