

SOLID STATE AREA LIGHTING

RSB SERIES-PLED

FEATURES

Luminaire and Arm

Spun aluminum housing with sidewalls having a maximum 1° of taper. A rollformed, vented aluminum flange is hemmed into the housing opening to provide support for the PLED Optical Module.

Arm is one piece extruded and is secured to Housing and Pole with internal draw bolts. A reinforcing plate inside the fixture body prevents sagging. Arm is flat cut to mate with square poles and requires a cast round pole adapter for mounting to round poles. (Specify pole diameter)

PLED™ Optics

Emitters (LED's) are arrayed on a metal core PCB panel with each emitter located on a copper thermal transfer pad and enclosed by an LED refractor. LED optics completely seal each individual emitter to meet an IP66 rating. In asymmetric distributions, a micro-reflector inside the refractor re-directs the house side emitter output towards the street side and functions as a house side shielding element. Refractors are injection molded H12 acrylic. Each LED refractor is sealed to the PCB over an emitter and all refractors are retained by an aluminum frame. Any one Panel, or group of Panels in a luminaire, have the same optical pattern. LED refractors produce standard site/area distributions. Panels are field replaceable and field rotatable in 90° increments.

LED Emitters

High output LED's are utilized with drive currents ranging from 350mA to 875mA. 70CRI Minimum. LED's are available in standard Neutral White (4000K), or optional Cool White (5000K) or Warm White (3000K). Consult Factory for other LED options.

LED Driver

Constant current electronic with a power factor of >.90 and a minimum operating temperature of -40°F/-40°C. Driver(s) is/are UL and cUL recognized. In-line terminal blocks facilitate wiring between the driver and optical arrays. Drivers accept an input of 120-277V, 50/60Hz or 347V-480V, 50,60Hz. (0 - 10V dimmable driver is standard. Driver has a minimum of 3KV internal surge protection. Luminaire supplied with 20KV surge protector for field installation.)

Amber LED's

PCA (Phosphor Converted Amber) LED's utilize phosphors to create color output similar to LPS lamps and have a slight output in the blue spectral bandwidth. TRA (True Amber) LED's utilize material that emits light in the amber spectral bandwidth only without the use of phosphors.

Finish

Polyester powder coat incorporates four step iron phosphate process to pretreat metal surface for maximum adhesion. Top coat is baked at 400°F for maximum hardness and exterior durability.

PROJECT NAME: _____

FIXTURE TYPE: _____

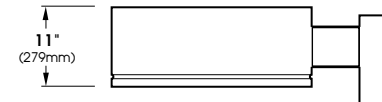
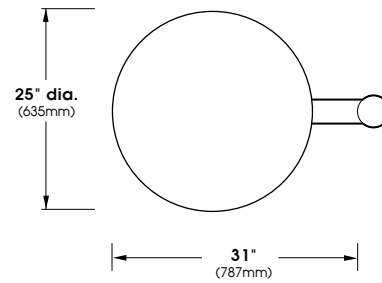

RSB25

Patent pending

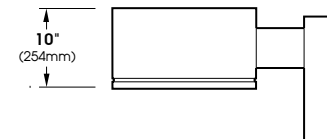
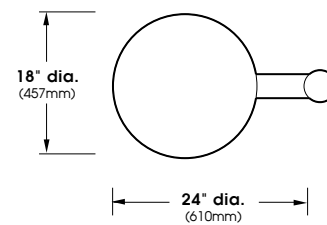

RSB18

Patent pending

RSB SERIES - PLED

SPECIFICATIONS

Pole Drilling Template

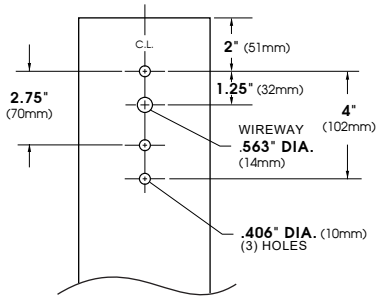

Wall Mount

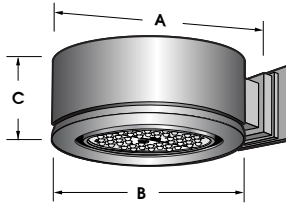

Fixture	A	B	C
RSB25	31" (787mm)	25" (635mm)	11" (279mm)
RSB18	24" (607mm)	18" (457mm)	10" (254mm)

Extruded aluminum arm and cast aluminum wall bracket assembly provided with built in gasketed wire access for fixture/supply wire connection.

Wall Plate

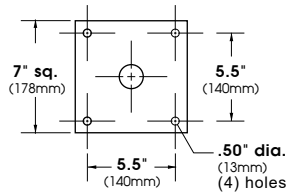

PLED™ Modules

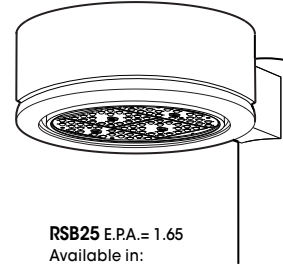

RSB25 E.P.A.= 1.65
Available in:
80 LED Module Max

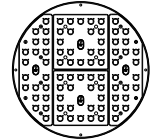

80 LED Module

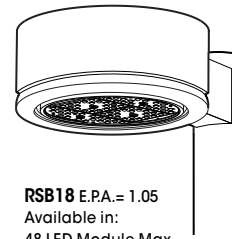

RSB18 E.P.A.= 1.05
Available in:
48 LED Module Max

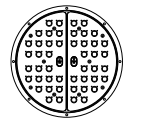

48 LED Module

ORDERING INFORMATION

Spec/Order Example: RSB18/PLED-II/48LED-350mA/NW/347/1/RAL-7005-S

Luminaire	Optics	LED Mode			Voltage	Mounting	Finish	Options
Luminaire	Optics	LED			Voltage	Mounting	Finish	Options
<input type="checkbox"/> RSB25-PLED <input type="checkbox"/> RSB18-PLED	PLED™ Distribution Type <input type="checkbox"/> Type II PLED-II <input type="checkbox"/> Type II Front Row PLED-II-FR <input type="checkbox"/> Type III Med. PLED-III-M <input type="checkbox"/> Type III Wide PLED-III-W <input type="checkbox"/> Type IV PLED-IV <input type="checkbox"/> Type IV PLED-IV-FT <input type="checkbox"/> Type V Narrow PLED-VSQ-N <input type="checkbox"/> Type V Med. PLED-VSQ-M <input type="checkbox"/> Type V Wide PLED-VSQ-W	# of LEDs RSB25 <input type="checkbox"/> 80LED ¹ <input type="checkbox"/> 48LED <input type="checkbox"/> 36LED RSB18 <input type="checkbox"/> 48LED ¹ <input type="checkbox"/> 36LED <input type="checkbox"/> 20LED	Drive Current <input type="checkbox"/> 1050mA ² <input type="checkbox"/> 875mA ² <input type="checkbox"/> 700mA ² <input type="checkbox"/> 525mA <input type="checkbox"/> 350mA	Color Temp - CCT <input type="checkbox"/> NW (4000K)* <small>*Standard</small> <input type="checkbox"/> CW (5000K) <input type="checkbox"/> WW (3000K) Other LED Colors Available Consult Factory <input type="checkbox"/> Amber ³ <input type="checkbox"/> Phosphor Converted Amber PCA ⁴ <input type="checkbox"/> True Amber ⁵ TRA	<input type="checkbox"/> 120 <input type="checkbox"/> 208 <input type="checkbox"/> 240 <input type="checkbox"/> 277 <input type="checkbox"/> 347 <input type="checkbox"/> 480	<input type="checkbox"/> 1 <input type="checkbox"/> 2-90 <input type="checkbox"/> 2-180 <input type="checkbox"/> 3-90 <input type="checkbox"/> 3-120 <input type="checkbox"/> 4-90 Wallmount <input type="checkbox"/> WM Post Top <input type="checkbox"/> PT	Standard Textured Finish <input type="checkbox"/> Black RAL-9005-T <input type="checkbox"/> White RAL-9003-T <input type="checkbox"/> Grey RAL-7004-T <input type="checkbox"/> Dark Bronze RAL-8019-T <input type="checkbox"/> Green RAL-6005-T For smooth finish replace suffix "T" with suffix "S" (Example: RAL-9500-S) Consult factor for custom colors	<input type="checkbox"/> Stem Mount + Length(in) (48" Max) SM+L <input type="checkbox"/> Chain Mount + Length(in) (48" Max) CM+L <input type="checkbox"/> Internal House Side Shield inc. LED Count (Example: HS-PLED/48) HS-PLED <input type="checkbox"/> Twist Lock Receptable Only TPR <input type="checkbox"/> 7-Pin Twist Lock Receptable Only TPR7 <input type="checkbox"/> High-Low Dimming for Switch by Others/Select Levels 50/100 or 25/100 (Example: HLSW/25) HLSW <input type="checkbox"/> Photo Cell + Voltage (Example: PC120V) PC+V <input type="checkbox"/> Single Fuse (120V, 277V) SF <input type="checkbox"/> Double Fuse (208V, 240V) DF <input type="checkbox"/> Blue-Tooth Programmable Photo/Motion Sensor (Factory - Motion 50/100; Photo 75c) MS-F311
NOTES: 1 - 875mA maximum 2 - 700mA and 875mA not for use with TRA LED's 3 - Narrow band Ambers have no Definable CCT equivalent 4 - 700mA maximum 5 - Available in 350mA & 525mA drive currents only								



RSB SERIES - PLED

LED/ Electrical Guide (pg. 1)

LED Count	Source Type	Source	Initial Lumens - 4000K CCT	Initial Lumens - 3000K CCT	Initial Lumens - 5000K CCT	L70 greater than (HR)	Starting Temp.	System Watts	Volts	Max Input Amps
RSB18										
20	LED	20 PLED® Optical Module - 350mA	2842 - 3262	2700 - 3098	2984 - 3424	90,000+	-40°F	22/28	120 277 347	.19/.24 .08/.11 .07/.08
20	LED	20 PLED® Optical Module - 525mA	4042 - 4637	3839 - 4405	4243 - 4868	90,000+	-40°F	33/39	120 277 347	.28/.33 .12/.14 .10/.12
20	LED	20 PLED® Optical Module - 700mA	5083 - 5832	4829 - 5540	5337 - 6123	90,000+	-40°F	44/50	120 277 347	.37/.42 .16/.18 .13/.15
20	LED	20 PLED® Optical Module - 875mA	6108 - 7008	5802 - 6657	6413 - 7358	90,000+	-40°F	56/62	120 277 347	.47/.52 .21/.23 .17/.18
20	LED	20 PLED® Optical Module - 1050mA	7086 - 8131	6732 - 7725	7441 - 8537	90,000+	-40°F	67/73	120 277 347	.56/.61 .25/.27 .20/.21
36	LED	36 PLED® Optical Module - 350mA	5116 - 5871	4860 - 5577	5371 - 6164	90,000+	-40°F	40/46	120 277 347	.34/.39 .15/.17 .12/.14
36	LED	36 PLED® Optical Module - 525mA	7274 - 8346	6910 - 7929	7638 - 8763	90,000+	-40°F	60/66	120 277 347	.50/.55 .22/.24 .18/.20
36	LED	36 PLED® Optical Module - 700mA	9149 - 10497	8691 - 9972	9606 - 11022	90,000+	-40°F	79/85	120 277 347	.66/.71 .29/.31 .23/.25
36	LED	36 PLED® Optical Module - 875mA	10994 - 12614	10444 - 11983	11544 - 13245	90,000+	-40°F	101/107	120 277 347	.85/.90 .37/.39 .30/.31
36	LED	36 PLED® Optical Module - 1050mA	12755 - 14635	12117 - 13903	13392 - 15367	90,000+	-40°F	120/126	120 277 347	1.00/1.05 .44/.46 .35/.37
48	LED	48 PLED® Optical Module - 350mA	6821 - 7827	6480 - 7435	7162 - 8218	90,000+	-40°F	53/59	120 277 347	.45/.50 .20/.22 .16/.17
48	LED	48 PLED® Optical Module - 525mA	9699 - 11128	9214 - 10572	10183 - 11684	90,000+	-40°F	79/85	120 277 347	.66/.71 .29/.31 .23/.25
48	LED	48 PLED® Optical Module - 700mA	12199 - 13398	11589 - 13296	12808 - 14696	90,000+	-40°F	106/112	120 277 347	.89/.94 .39/.41 .31/.33
48	LED	48 PLED® Optical Module - 875mA	14659 - 16819	13926 - 15978	15392 - 17660	90,000+	-40°F	134/140	120 277 347	1.12/1.17 .49/.51 .39/.41
RSB25										
36	LED	36 PLED® Optical Module - 350mA	5126 - 5882	4870 - 5588	5383 - 6176	90,000+	-40°F	40/46	120 277 347	.34/.39 .15/.17 .12/.14
36	LED	36 PLED® Optical Module - 525mA	7382 - 8470	7013 - 8047	7751 - 8894	90,000+	-40°F	59/65	120 277 347	.50/.55 .23/.24 .17/.19
36	LED	36 PLED® Optical Module - 700mA	9362 - 10742	8894 - 10205	9830 - 11279	90,000+	-40°F	79/85	120 277 347	.66/.71 .29/.31 .23/.25
36	LED	36 PLED® Optical Module - 875mA	10719 - 12298	10183 - 11682	11254 - 12913	90,000+	-40°F	103/109	120 277 347	.86/.91 .38/.40 .30/.32
36	LED	36 PLED® Optical Module - 1050mA	12435 - 14268	11813 - 13554	13057 - 14981	90,000+	-40°F	116/122	120 277 347	.97/1.02 .42/.44 .34/.36
48	LED	48 PLED® Optical Module - 350mA	6835 - 7843	6493 - 7450	7177 - 8235	90,000+	-40°F	53/59	120 277 347	.45/.50 .20/.23 .16/.17



RSB SERIES - PLED

LED/ Electrical Guide (pg. 2)

LED Count	Source Type	Source	Initial Lumens - 4000K CCT	Initial Lumens - 3000K CCT	Initial Lumens - 5000K CCT	L70 greater than (HR)	Starting Temp.	System Watts	Volts	Max Input Amps
RSB25										
48	LED	48 PLED® Optical Module - 525mA	9843 - 11294	9351 - 10729	10336 - 11859	90,000+	-40°F	78/84	120 277 347	.65/.70 .29/.31 .23/.25
48	LED	48 PLED® Optical Module - 700mA	12483 - 14323	11859 - 13607	13107 - 15038	90,000+	-40°F	105/111	120 277 347	.88/.93 .38/.40 .31/.32
48	LED	48 PLED® Optical Module - 875mA	14292 - 16397	13577 - 15577	15006 - 17217	90,000+	-40°F	137/143	120 277 347	1.15/1.20 .50/.52 .40/.42
48	LED	48 PLED® Optical Module - 1050mA	16581 - 19024	15752 - 18073	17409 - 19975	90,000+	-40°F	154/160	120 277 347	1.29/1.34 .56/.58 .45/.47
80	LED	80 PLED® Optical Module - 350mA	11392 - 13071	10823 - 12418	11962 - 13724	90,000+	-40°F	88/94	120 277 347	.74/.79 .32/.34 .26/.27
80	LED	80 PLED® Optical Module - 525mA	16406 - 18823	15585 - 17882	17226 - 19765	90,000+	-40°F	130/136	120 277 347	1.09/1.14 .47/.50 .38/.40
80	LED	80 PLED® Optical Module - 700mA	20805 - 23871	19765 - 22678	21845 - 25065	90,000+	-40°F	174/180	120 277 347	1.45/1.50 .63/.65 .50/.52
80	LED	80 PLED® Optical Module - 875mA	23819 - 27329	22628 - 25962	25010 - 28695	90,000+	-40°F	226/232	120 277 347	1.89/1.94 .82/.84 .66/.69

Phosphor Converted Amber LED

RSB18										
20	PCA - LED	20 PLED® Optical Module - 350mA	1478 - 1696			51,000+	-40°F	25	120 277 347	.21 .10 .08
20	PCA - LED	20 PLED® Optical Module - 525mA	2102 - 2411			51,000+	-40°F	37	120 277 347	.31 .14 .11
20	PCA - LED	20 PLED® Optical Module - 700mA	2643 - 3033			51,000+	-40°F	50	120 277 347	.42 .18 .15
36	PCA - LED	36 PLED® Optical Module - 350mA	2660 - 3053			51,000+	-40°F	45	120 277 347	.38 .17 .13
36	PCA - LED	36 PLED® Optical Module - 525mA	3783 - 4340			51,000+	-40°F	67	120 277 347	.56 .25 .20
36	PCA - LED	36 PLED® Optical Module - 700mA	4757 - 5459			51,000+	-40°F	89	120 277 347	.75 .33 .26
48	PCA - LED	48 PLED® Optical Module - 350mA	3547 - 4070			51,000+	-40°F	59	120 277 347	.50 .22 .17
48	PCA - LED	48 PLED® Optical Module - 525mA	5043 - 5787			51,000+	-40°F	89	120 277 347	.75 .33 .26
48	PCA - LED	48 PLED® Optical Module - 700mA	6343 - 7278			51,000+	-40°F	118	120 277 347	.99 .43 .34
RSB25										
36	PCA - LED	36 PLED® Optical Module - 350mA	2666 - 3059			51,000+	-40°F	45	120 277 347	.38 .17 .13
36	PCA - LED	36 PLED® Optical Module - 525mA	3839 - 4405			51,000+	-40°F	66	120 277 347	.56 .24 .19



RSB SERIES - PLED

LED Count	Source Type	Source	Initial Lumens - 4000K CCT	Initial Lumens - 3000K CCT	Initial Lumens - 5000K CCT	L70 greater than (HR)	Starting Temp.	System Watts	Volts	Max Input Amps
-----------	-------------	--------	----------------------------	----------------------------	----------------------------	-----------------------	----------------	--------------	-------	----------------

Phosphor Converted Amber LED

RSB25

36	PCA - LED	36 PLED® Optical Module - 700mA	4868 - 5586			51,000+	-40°F	88	120	.74
									277	.32
									347	.26
48	PCA - LED	48 PLED® Optical Module - 350mA	3554 - 4078			51,000+	-40°F	59	120	.50
									277	.22
									347	.17
48	PCA - LED	48 PLED® Optical Module - 525mA	5119 - 5873			51,000+	-40°F	87	120	.73
									277	.32
									347	.25
48	PCA - LED	48 PLED® Optical Module - 700mA	6491 - 7448			51,000+	-40°F	117	120	.98
									277	.43
									347	.34
80	PCA - LED	80 PLED® Optical Module - 350mA	11392 - 13071			51,000+	-40°F	98	120	.82
									277	.36
									347	.29
80	PCA - LED	80 PLED® Optical Module - 525mA	16406 - 18823			51,000+	-40°F	145	120	1.21
									277	.52
									347	.42
80	PCA - LED	80 PLED® Optical Module - 700mA	20805 - 23871			51,000+	-40°F	195	120	1.63
									277	.71
									347	.57

True Amber LED - 590nm

RSB18

20	TRA - LED	20 PLED® Optical Module - 350mA	854 - 979			66,500+	-40°F	18	120	.15
									277	.07
									347	.06
20	TRA - LED	20 PLED® Optical Module - 700mA	1022 - 1172			66,500+	-40°F	26	120	.22
									277	.10
									347	.08
36	TRA - LED	36 PLED® Optical Module - 350mA	1536 - 1762			66,500+	-40°F	31	120	.26
									277	.12
									347	.09
36	TRA - LED	36 PLED® Optical Module - 525mA	1838 - 2109			66,500+	-40°F	47	120	.40
									277	.17
									347	.14
48	TRA - LED	48 PLED® Optical Module - 350mA	2048 - 2350			66,500+	-40°F	41	120	.35
									277	.15
									347	.12
48	TRA - LED	48 PLED® Optical Module - 525mA	2451 - 2812			66,500+	-40°F	62	120	.52
									277	.23
									347	.18

RSB25

36	TRA - LED	36 PLED® Optical Module - 350mA	1539 - 1766			66,500+	-40°F	31	120	.26
									277	.12
									347	.09
36	TRA - LED	36 PLED® Optical Module - 525mA	1866 - 2140			66,500+	-40°F	46	120	.39
									277	.18
									347	.14
48	TRA - LED	48 PLED® Optical Module - 350mA	2053 - 2355			66,500+	-40°F	41	120	.35
									277	.19
									347	.12
48	TRA - LED	48 PLED® Optical Module - 525mA	2488 - 2854			66,500+	-40°F	61	120	.51
									277	.22
									347	.18
80	TRA - LED	80 PLED® Optical Module - 350mA	3421 - 3925			66,500+	-40°F	67	120	.56
									277	.25
									347	.20



RSB SERIES - PLED

LED Count	Source Type	Source	Initial Lumens - 4000K CCT	Initial Lumens - 3000K CCT	Initial Lumens - 5000K CCT	L70 greater than (HR)	Starting Temp.	System Watts	Volts	Max Input Amps
True Amber LED - 590nm										

RSB25										
80	TRA - LED	80 PLED® Optical Module - 525mA	4146 - 4757			66,500+	-40°F	101	120 277 347	.85 .37 .30

- 1) Max Input Amps is the highest of starting, operating, or open circuit currents
- 2) System Watts includes the source watts and all driver components.
- 3) Lumen values for LED Modules vary according to the distribution type
- 4) For Wattage and Max Input Amps showing two values, use the higher value for luminaires with lit uplight windows (-L & -M)
- 5) PCA and TRA LED optics not recommended for use with lit uplight window models (-L & -M)
- 6) Fuse value should be sufficient to protect all wiring components. For electronic driver and LED component protection, use 20KV surge suppressors.
- 7) L70(10K) – TM-21 6x rule applied

WARNING: All fixtures must be installed in accordance with local codes or the National Electrical Code. Failure to do so may result in serious personal injury.



SOLID STATE AREA LIGHTING

RSB SERIES - VLED

FEATURES

Luminaire and Arm

Heavy walled one-piece aluminum spinning with single reveal for additional rigidity. Arm is heavy cast low copper aluminum (A356 alloy, < .02% copper) and also functions as driver compartment.

VLED® Optics

Low copper (A356 Alloy; <0.2% Cu) cast aluminum housing. Integrated clear tempered glass lens sealed with a continuous silicone gasket protects emitters (LED's), Reflector-Prism optics, and seals the module from water intrusion and environmental contaminants. Module is sealed to meet an IP67 rating. Each emitter is optically controlled by a Reflector-Prism injection molded from H12 acrylic (3 types per module; one from 0° - 50°; one from 50° - 65°; one from 65° - 72°). Each Reflector-Prism is secured to an optical plate made of matte black anodized aluminum has indexing pins for precise aiming. The optical plate locates every Reflector-Prism over an emitter, are inserted to the optical plate from above and are secured with a UV curing adhesive. The Reflector-Prisms are arrayed to produce IES Type II, III, IV, and V-SQ distributions. The entire Optical Module is field rotatable in 90° increments. Both module and drivers are factory wired using water resistant, insulated cord.

LED Emitters

High output LED's are utilized with drive currents ranging from 350mA to 700mA. 70CRI Minimum. LED's are available in standard Neutral White (4000K), or optional Cool White (5000K) or Warm White (3000K). Consult Factory for other LED options.

LED Driver

Constant current programmable electronic with a power factor of >.90 and a minimum operating temperature of -40°F/-40°C. Driver(s) is/are UL and cUL recognized. In-line terminal blocks facilitate wiring between the driver and optical arrays. Drivers accept an input of 120-277V, 50/60Hz or 347V-480V, 50,60Hz. (0 - 10V dimmable driver is standard. Driver has a minimum of 3KV internal surge protection. Luminaire supplied with 20KV surge protector for field installation.)

Amber LED's

PCA (Phosphor Converted Amber) LED's utilize phosphors to create color output similar to LPS lamps and have a slight output in the blue spectral bandwidth. TRA (True Amber) LED's utilize material that emits light in the amber spectral bandwidth only without the use of phosphors.

Finish

Polyester powder coat incorporates four step iron phosphate process to pretreat metal surface for maximum adhesion. Top coat is baked at 400°F for maximum hardness and exterior durability.

PROJECT NAME: _____

FIXTURE TYPE: _____

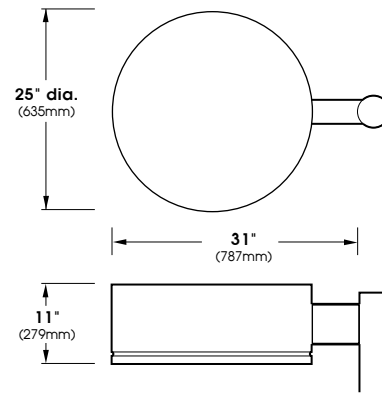

RSB25

Patent pending

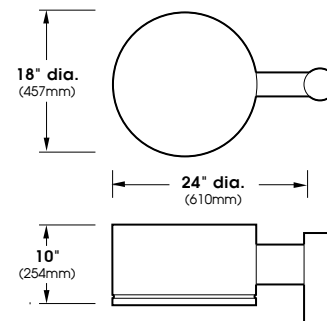

RSB18

Patent pending

RSB SERIES - VLED

SPECIFICATIONS

Pole Drilling Template

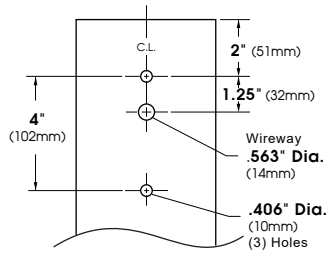

Wall Mount

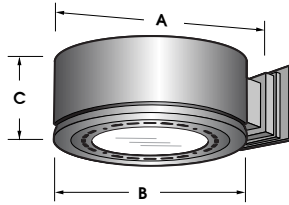

Fixture	A	B	C
RSB25	31" (787mm)	25" (635mm)	11" (279mm)
RSB18	24" (607mm)	18" (457mm)	10" (254mm)

Extruded aluminum arm and cast aluminum wall bracket assembly provided with built in gasketed wire access for fixture/supply wire connection.

Wall Plate

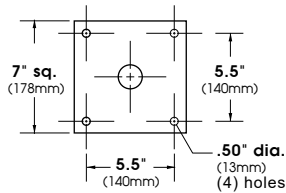

LED Power Array™ Modules

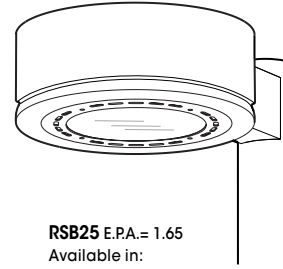

RSB25 E.P.A. = 1.65
Available in:
120 LED Module Max

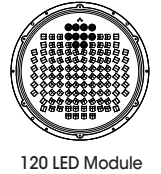

120 LED Module

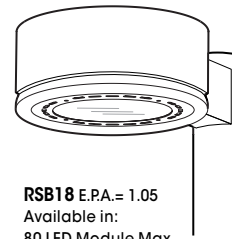

RSB18 E.P.A. = 1.05
Available in:
80 LED Module Max

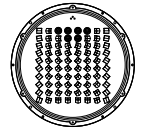

80 LED Module

ORDERING INFORMATION

Spec/Order Example: RSB25/VLED-III-W/80LED-525mA/NW/277/1/RAL-7005-S

Luminaire	Optics	LED Mode	Voltage	Mounting	Finish	Options		
Luminaire	Optics	LED	Voltage	Mounting	Finish	Options		
<input type="checkbox"/> RSB25-VLED <input type="checkbox"/> RSB18-VLED	VLED® IES Distribution Type <input type="checkbox"/> Type II VLED-II <input type="checkbox"/> Type III VLED-III <input type="checkbox"/> Type IV VLED-IV <input type="checkbox"/> Type V Med. VLED-V-SQ	# of LEDs RSB25 <input type="checkbox"/> 120LED ¹ <input type="checkbox"/> 100LED ¹ <input type="checkbox"/> 80LED <input type="checkbox"/> 64LED RSB18 <input type="checkbox"/> 80LED ¹ <input type="checkbox"/> 64LED <input type="checkbox"/> 48LED	Drive Current <input type="checkbox"/> 700mA <input type="checkbox"/> 525mA <input type="checkbox"/> 350mA	Color Temp - CCT <input type="checkbox"/> NW (4000K)* *Standard <input type="checkbox"/> CW (5000K) <input type="checkbox"/> WW (3000K) Other LED Colors Available Consult Factory <input type="checkbox"/> Amber ² <input type="checkbox"/> Phosphor Converted Amber PCA <input type="checkbox"/> True Amber ¹ TRA	<input type="checkbox"/> 120 <input type="checkbox"/> 208 <input type="checkbox"/> 240 <input type="checkbox"/> 277 <input type="checkbox"/> 347 <input type="checkbox"/> 480	Wallmount <input type="checkbox"/> 1 <input type="checkbox"/> 2-90 <input type="checkbox"/> 2-180 <input type="checkbox"/> 3-90 <input type="checkbox"/> 3-120 <input type="checkbox"/> 4-90 Post Top <input type="checkbox"/> WM <input type="checkbox"/> PT	Standard Textured Finish <input type="checkbox"/> Black RAL-9005-T <input type="checkbox"/> White RAL-9003-T <input type="checkbox"/> Grey RAL-7004-T <input type="checkbox"/> Dark Bronze RAL-8019-T <input type="checkbox"/> Green RAL-6005-T For smooth finish replace suffix "T" with suffix "S" (Example: RAL-9500-S) Consult factor for custom colors	<input type="checkbox"/> Internal House Side Shields inc. LED Count (Example: HS-VLED/48) HS-VLED <input type="checkbox"/> Twist Lock Receptable Only TPR <input type="checkbox"/> 7-Pin Twist Lock Receptable Only TPR7 <input type="checkbox"/> High-Low Dimming for Switch by Others/Select Levels 50/100 or 25/100 (Example: HLSW/25) HLSW <input type="checkbox"/> Photo Cell + Voltage (Example: PC120V) PC+V <input type="checkbox"/> Single Fuse (120V, 277V) SF <input type="checkbox"/> Double Fuse (208V, 240V) DF <input type="checkbox"/> Programmable Photo/Motion Sensor (Factory - Motion 50/100; Photo 75c) MS-F211 <input type="checkbox"/> Remote Motion Sensor Configurator MS-FC10
		NOTES: 1 - Available in 350mA & 525mA Drive Currents only 2 - Narrow band Ambers have no definable CCT equivalent						



RSB SERIES - VLED

LED Count	Source Type	Source	Initial Lumens - 4000K CCT	Initial Lumens - 3000K CCT	Initial Lumens - 5000K CCT	L70 greater than (HR)	Starting Temp.	System Watts	Volts	Max Input Amps
RSB18										
48	White LED	48 VLED® Optical Module - 350mA	6169 -	5860 -	6478 -	90,000+	-40°C	53/59	120	0.44/0.49
			6558	6230	6886				277	0.19/0.21
									347	0.15/0.17
48	White LED	48 VLED® Optical Module - 525mA	8494 -	8069 -	8919 -	90,000+	-40°C	77/83	120	0.64/0.69
			9031	8579	9482				277	0.28/0.3
									347	0.22/0.24
48	White LED	48 VLED® Optical Module - 700mA	10635 -	10103 -	11167 -	90,000+	-40°C	103/109	120	0.86/0.91
			11307	10742	11872				277	0.37/0.39
									347	0.3/0.31
64	White LED	64 VLED® Optical Module - 350mA	8225 -	7813 -	8636 -	90,000+	-40°C	69/75	120	0.58/0.63
			8338	7921	8755				277	0.25/0.27
									347	0.2/0.22
64	White LED	64 VLED® Optical Module - 525mA	11325 -	10759 -	11891 -	90,000+	-40°C	102/108	120	0.85/0.9
			11481	10907	12055				277	0.37/0.39
									347	0.29/0.31
80	White LED	80 VLED® Optical Module - 350mA	9675 -	9191 -	10159 -	90,000+	-40°C	87/93	120	0.73/0.78
			9808	9317	10298				277	0.31/0.34
									347	0.25/0.27
80	White LED	80 VLED® Optical Module - 525mA	13189 -	12529 -	13848 -	90,000+	-40°C	127/133	120	1.06/1.11
			13370	12701	14038				277	0.46/0.48
									347	0.37/0.38
RSB25										
48	White LED	48 VLED® Optical Module - 350mA	6169 -	5860 -	6478 -	90,000+	-40°C	53/59	120	0.44/0.49
			6558	6230	6886				277	0.19/0.21
									347	0.15/0.17
48	White LED	48 VLED® Optical Module - 525mA	8494 -	8069 -	8919 -	90,000+	-40°C	75/81	120	0.63/0.68
			9031	8579	9482				277	0.27/0.29
									347	0.22/0.23
48	White LED	48 VLED® Optical Module - 700mA	10635 -	10103 -	11167 -	90,000+	-40°C	105/111	120	0.88/0.93
			11307	10742	11872				277	0.38/0.4
									347	0.3/0.32
64	White LED	64 VLED® Optical Module - 350mA	8225 -	7813 -	8636 -	90,000+	-40°C	71/77	120	0.59/0.64
			8745	8308	9183				277	0.26/0.28
									347	0.2/0.22
64	White LED	64 VLED® Optical Module - 525mA	11325 -	10759 -	11891 -	90,000+	-40°C	103/109	120	0.86/0.91
			12042	11440	12644				277	0.37/0.39
									347	0.3/0.31
64	White LED	64 VLED® Optical Module - 700mA	13190 -	12531 -	13849 -	90,000+	-40°C	140/146	120	1.17/1.22
			13824	13133	14516				277	0.51/0.53
									347	0.4/0.42
80	White LED	80 VLED® Optical Module - 350mA	9675 -	9191 -	10159 -	90,000+	-40°C	87/93	120	0.73/0.78
			10286	9772	10801				277	0.31/0.34
									347	0.25/0.27
80	White LED	80 VLED® Optical Module - 525mA	13189 -	12529 -	13848 -	90,000+	-40°C	127/133	120	1.06/1.11
			14023	13322	14724				277	0.46/0.48
									347	0.37/0.38
80	White LED	80 VLED® Optical Module - 700mA	16487 -	15662 -	17311 -	90,000+	-40°C	173/179	120	1.44/1.49
			17280	16416	18144				277	0.62/0.65
									347	0.5/0.52
100	White LED	100 VLED® Optical Module - 350mA	11776 -	11187 -	12365 -	90,000+	-40°C	108/114	120	0.9/0.95
			12304	11689	12919				277	0.39/0.41
									347	0.31/0.33
100	White LED	100 VLED® Optical Module - 525mA	16291 -	15476 -	17106 -	90,000+	-40°C	160/166	120	1.33/1.38
			17025	16174	17877				277	0.58/0.6
									347	0.46/0.48
120	White LED	120 VLED® Optical Module - 350mA	14129 -	13423 -	14836 -	90,000+	-40°C	129/135	120	1.08/1.13
			14765	14027	15503				277	0.47/0.49
									347	0.37/0.39
120	White LED	120 VLED® Optical Module - 525mA	19549 -	18572 -	20527 -	90,000+	-40°C	192/198	120	1.6/1.65
			20430	19408	21451				277	0.69/0.71
									347	0.55/0.57



RSB SERIES - VLED

LED Count	Source Type	Source	Initial Lumens	L70 greater than (HR)	Starting Temp.	System Watts	Volts	Max Input Amps
Phosphor Converted Amber LED								
RSB18								
48	PC Amber	48 VLED® Optical Module – 350mA	3208 - 3410	51,000+	-40°C	59	120 277 347	0.49 0.21 0.17
48	PC Amber	48 VLED® Optical Module – 525mA	4417 - 4696	51,000+	-40°C	86	120 277 347	0.72 0.31 0.25
48	PC Amber	48 VLED® Optical Module – 700mA	5530 - 5880	51,000+	-40°C	115	120 277 347	0.96 0.42 0.33
64	PC Amber	64 VLED® Optical Module – 350mA	4277 - 4547	51,000+	-40°C	80	120 277 347	0.67 0.29 0.23
64	PC Amber	64 VLED® Optical Module – 525mA	5889 - 6262	51,000+	-40°C	114	120 277 347	0.95 0.41 0.33
80	PC Amber	80 VLED® Optical Module – 350mA	5031 - 5349	51,000+	-40°C	97	120 277 347	0.81 0.35 0.28
80	PC Amber	80 VLED® Optical Module – 525mA	6858 - 7292	51,000+	-40°C	142	120 277 347	1.18 0.51 0.41
RSB25								
48	PC Amber	48 VLED® Optical Module – 350mA	3208 - 3410	51,000+	-40°C	60	120 277 347	0.50 0.22 0.17
48	PC Amber	48 VLED® Optical Module – 525mA	4417 - 4696	51,000+	-40°C	84	120 277 347	0.70 0.30 0.24
48	PC Amber	48 VLED® Optical Module – 700mA	5530 - 5880	51,000+	-40°C	118	120 277 347	0.98 0.43 0.34
64	PC Amber	64 VLED® Optical Module – 350mA	4277 - 4547	51,000+	-40°C	80	120 277 347	0.67 0.29 0.23
64	PC Amber	64 VLED® Optical Module – 525mA	5889 - 6262	51,000+	-40°C	116	120 277 347	0.97 0.42 0.33
64	PC Amber	64 VLED® Optical Module – 700mA	6859 - 7189	51,000+	-40°C	157	120 277 347	1.31 0.57 0.45
80	PC Amber	80 VLED® Optical Module – 350mA	5031 - 5349	51,000+	-40°C	98	120 277 347	0.82 0.35 0.28
80	PC Amber	80 VLED® Optical Module – 525mA	6858 - 7292	51,000+	-40°C	142	120 277 347	1.18 0.51 0.41
80	PC Amber	80 VLED® Optical Module – 700mA	8573 - 8986	51,000+	-40°C	194	120 277 347	1.62 0.70 0.56
100	PC Amber	100 VLED® Optical Module – 350mA	6124 - 6398	51,000+	-40°C	121	120 277 347	1.01 0.44 0.35
100	PC Amber	100 VLED® Optical Module – 525mA	8471 - 8853	51,000+	-40°C	179	120 277 347	1.49 0.65 0.52
120	PC Amber	120 VLED® Optical Module – 350mA	7347 - 7678	51,000+	-40°C	145	120 277 347	1.21 0.52 0.42
120	PC Amber	120 VLED® Optical Module – 525mA	10166 - 10624	51,000+	-40°C	215	120 277 347	1.79 0.78 0.62



RSB SERIES - VLED

LED Count	Source Type	Source	Initial Lumens	L70 greater than (HR)	Starting Temp.	System Watts	Volts	Max Input Amps
True Amber LED - 590nm								

RSB18

48	True Amber	48 VLED® Optical Module - 350mA	1841 - 1957	66,500+	-40°C	41	120	0.34
							277	0.15
							347	0.12
48	True Amber	48 VLED® Optical Module - 525mA	2535 - 2695	66,500+	-40°C	60	120	0.50
							277	0.22
							347	0.17
64	True Amber	64 VLED® Optical Module - 350mA	2454 - 2610	66,500+	-40°C	55	120	0.46
							277	0.20
							347	0.16
64	True Amber	64 VLED® Optical Module - 525mA	3379 - 3593	66,500+	-40°C	80	120	0.67
							277	0.29
							347	0.23
80	True Amber	80 VLED® Optical Module - 350mA	2887 - 3070	66,500+	-40°C	66	120	0.55
							277	0.24
							347	0.19
80	True Amber	80 VLED® Optical Module - 525mA	3936 - 4185	66,500+	-40°C	98	120	0.82
							277	0.35
							347	0.28

RSB25

48	True Amber	48 VLED® Optical Module - 350mA	1841 - 1957	66,500+	-40°C	41	120	0.34
							277	0.15
							347	0.12
48	True Amber	48 VLED® Optical Module - 525mA	2535 - 2695	66,500+	-40°C	58	120	0.48
							277	0.21
							347	0.17
64	True Amber	64 VLED® Optical Module - 350mA	2454 - 2610	66,500+	-40°C	55	120	0.46
							277	0.20
							347	0.16
64	True Amber	64 VLED® Optical Module - 525mA	3379 - 3593	66,500+	-40°C	80	120	0.67
							277	0.29
							347	0.23
80	True Amber	80 VLED® Optical Module - 350mA	2887 - 3070	66,500+	-40°C	67	120	0.56
							277	0.24
							347	0.19
80	True Amber	80 VLED® Optical Module - 525mA	3936 - 4185	66,500+	-40°C	98	120	0.82
							277	0.35
							347	0.28
100	True Amber	100 VLED® Optical Module - 350mA	3514 - 3672	66,500+	-40°C	83	120	0.69
							277	0.30
							347	0.24
100	True Amber	100 VLED® Optical Module - 525mA	4861 - 5080	66,500+	-40°C	123	120	1.03
							277	0.44
							347	0.35
120	True Amber	120 VLED® Optical Module - 350mA	4216 - 4406	66,500+	-40°C	99	120	0.83
							277	0.36
							347	0.29
120	True Amber	120 VLED® Optical Module - 525mA	5834 - 6097	66,500+	-40°C	148	120	1.23
							277	0.53
							347	0.43

