

SOLID STATE AREA LIGHTING

B3500 SERIES-LED

S P E C I F I C A T I O N S

HOUSING and RISER

Durable, corrosion resistant cast aluminum (A356 alloy; < 0.2% Cu) base, unlit riser and top cap, minimum .250" wall thickness. Lit riser is extruded, minimum .188" wall thickness. All visible welds are blended, all exposed hardware is stainless steel.

LED POWER ARRAY

Three-dimensional array consisting of 6 individual LED tubes fastened to a retaining plate equally spaced to provide 360° of even illumination output. Each LED tube consists of a circuit board populated with a multiple of LED's which is fastened to a radial aluminum heat sink. A white polycarbonate lens and end caps protect each LED tube's internal components and provides diffusion to prevent shadowing and striations.

OPAL LENS (WA)

Opal acrylic lens is located at the recess of the vertical flutes, protects the LED Module and provides uniform, diffuse illumination.

LED DRIVER

UL and cUL recognized High Power Factor, Constant Current LED drivers operate on input voltages from 120-277VAC, 50/60hz and is mechanically fastened to a retaining bracket. 347V and 480V options may utilize a step down transformer to the LED driver. Driver. Main power quick disconnect provided. Driver has a minimum 4KV of internal surge protection. Consult factory for other voltages. Dimming and High-Low Driver options available. 10KV & 20KV Surge Protector optional.

LED EMITTERS

High Output LED's are driven at 350mA for nominal 1 Watt output each. 70CRI Minimum. LED's are available in standard Neutral White (4000K), or optional Cool White (5000K) or Warm White (3000K). Consult Factory for other LED options.

FINISH

Electrostatically applied TGIC Polyester Powder Coat on substrate prepared with 20 PSI power wash at 140°F. Four step media blast and iron phosphate pretreatment for protection and paint adhesion. 400°F bake for maximum hardness and durability.

PROJECT NAME: _____

PROJECT TYPE: _____



B35EL-CAP

PATENT PENDING



2018241



B3500 SERIES-LED

S P E C I F I C A T I O N S

GROUND MOUNTING

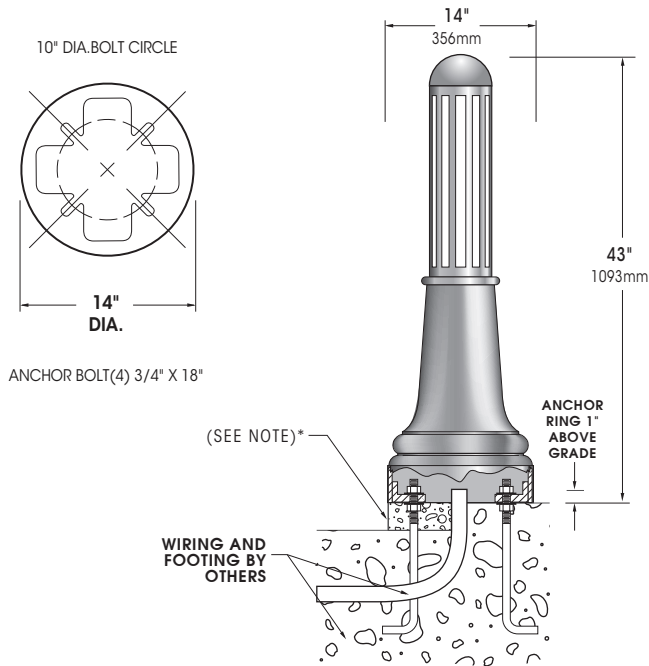

*When mounting in soil, anchor bolt fasteners and other hardware must be protected from soil by grouting.

LED MODULE

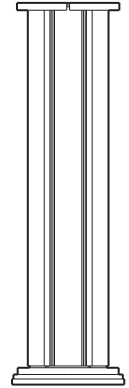
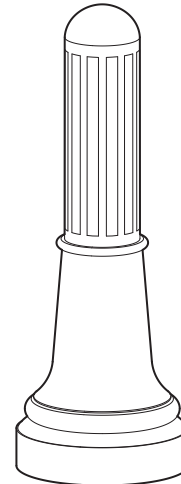

VPA - Vertical Array

B35EL-CAP-LED
VERTICAL POWER ARRAY™
 Available in:
 36 LED

Spec/Order Example: B35EL-CAP-VPA-SYM/24LED480/RAL-8019-T

L I G H T E D S P E C / O R D E R I N G I N F O R M A T I O N

MODEL	OPTICS	# of LED's	COLOR TEMP - CCT	VOLTAGE	FINISH	OPTIONS
MODEL	OPTICS	LED		FINISH	OPTIONS	
LIGHTED	VERTICAL POWER ARRAY OPAL ACRYLIC LENS	# of LEDs	COLOR TEMP - CCT	VOLTAGE	STANDARD TEXTURED FINISH	
<input type="checkbox"/> B35EL-CAP	<input type="checkbox"/> VERTICAL ARRAY VPA-SYM	<input type="checkbox"/> 36LED	<input type="checkbox"/> NW (4000K) Standard <input type="checkbox"/> CW (5000K) <input type="checkbox"/> WW (3000K) <small>OTHER LED COLORS AVAILABLE CONSULT FACTORY</small>	<input type="checkbox"/> 120 <input type="checkbox"/> 208 <input type="checkbox"/> 240 <input type="checkbox"/> 277 <input type="checkbox"/> 347 <input type="checkbox"/> 480	<input type="checkbox"/> BLACK RAL-9005-T <input type="checkbox"/> WHITE RAL-9003-T <input type="checkbox"/> GREY RAL-7004-T <input type="checkbox"/> DARK BRONZE RAL-8019-T <input type="checkbox"/> GREEN RAL-6005-T <small>FOR SMOOTH FINISH REPLACE SUFFIX "T" WITH SUFFIX "S" (EXAMPLE: RAL-9500-S) SEE USALTG.COM FOR ADDITIONAL COLORS</small>	<small>INTERNAL HOUSE SIDE SHIELD</small> <input type="checkbox"/> 90° HS90 <input type="checkbox"/> 135° HS135 <input type="checkbox"/> 180° HS180 <input type="checkbox"/> DIMMABLE DRIVER(S) (0-10V) DIM <input type="checkbox"/> HIGH-LOW DIMMING FOR HARDWIRED SWITCHING OR NON-INTEGRATED MOTION SENSOR HLSW <input type="checkbox"/> 10KV SURGE PROTECTOR 10SP <input type="checkbox"/> 20KV SURGE PROTECTOR (240V & 480V Only) ... 20SP <input type="checkbox"/> DUPLEX RECEPTACLE ... DUP <input type="checkbox"/> GROUND FAULT RECEPTACLE GFI <input type="checkbox"/> MAILBOX - SINGLE MBS <input type="checkbox"/> MAILBOX - DOUBLE ... MBD <input type="checkbox"/> BOLLARD EYE BOLT ... BEB <input type="checkbox"/> BALL CAP. BAL



B3500 SERIES-LED

S P E C I F I C A T I O N S

HOUSING and RISER

Durable, corrosion resistant cast aluminum (A356 alloy; < 0.2% Cu) base, riser and top cap, minimum .250" wall thickness. All visible welds are blended, all exposed hardware is stainless steel.

FINISH

Electrostatically applied TGIC Polyester Powder Coat on substrate prepared with 20 PSI power wash at 140°F. Four step media blast and iron phosphate pretreatment for protection and paint adhesion. 400°F bake for maximum hardness and durability.

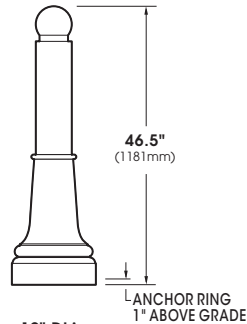

B 3 5 E - B A L



PATENT PENDING

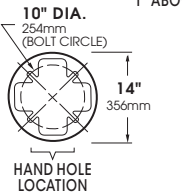
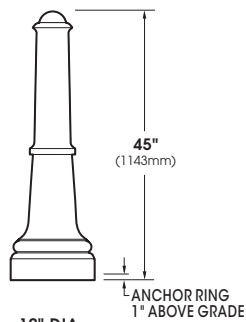

B 3 5 C - C A P



PATENT PENDING

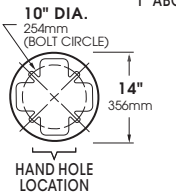
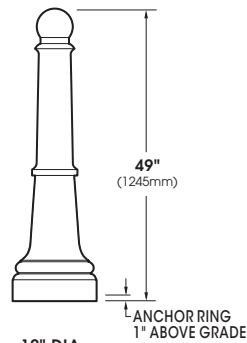

B 3 5 C - B A L



PATENT PENDING

ACCESSORIES

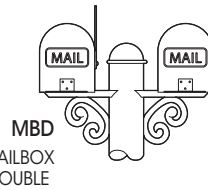
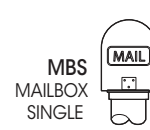

Mailboxes may be mounted post top or side mount.

Mailboxes are of durable, corrosion resistant, cast aluminum (A356 alloy; < .02% copper) and painted to match the decorative bollard.

Mailboxes include nonlocking pull latch and cast flag.

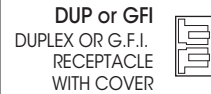

Specify Duplex or GFCI receptacle to mount in the outlet provision. Standard cover supplied. nd location.

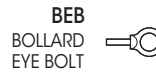

Eyebolts for barrier chain or cord. Specify eyebolt(s) height and location.

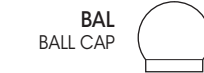

Unlit Example: B35C-CAP/RAL-6005-S

U N - L I G H T E D S P E C / O R D E R I N G I N F O R M A T I O N

MODEL	FINISH	ACCESSORIES
MODEL	FINISH	ACCESSORIES
UN-LIGHTED	STANDARD TEXTURED FINISH	
<input type="checkbox"/> B35E-BAL	<input type="checkbox"/> BLACK RAL-9005-T	<input type="checkbox"/> MAILBOX - SINGLE MBS
<input type="checkbox"/> B35C-CAP	<input type="checkbox"/> WHITE RAL-9003-T	<input type="checkbox"/> MAILBOX-DOUBLE MBD
<input type="checkbox"/> B35C-BAL	<input type="checkbox"/> GREY RAL-7004-T	<input type="checkbox"/> DUPLEX RECEPTACLE DUP
TO CONFIGURE, SHOW MODEL, FINISH AND ANY PERTINENT ACCESSORIES	<input type="checkbox"/> DARK BRONZE RAL-8019-T	<input type="checkbox"/> GROUND FAULT RECEPTACLE GFI
	<input type="checkbox"/> GREEN RAL-6005-T	<input type="checkbox"/> BALL CAP BAL
	FOR SMOOTH FINISH REPLACE SUFFIX "T" WITH SUFFIX "S" (EXAMPLE: RAL-9500-S)	BOLLARD EYE BOLT
	SEE USALTG.COM FOR ADDITIONAL COLORS	<input type="checkbox"/> SINGLE BEB
		<input type="checkbox"/> DOUBLE BEB/2-180

